

Eleventh Year of Service

JUN 3 1

RADIO ENGINEERING

LABORATORY COPY
Vol. XI JUNE, 1931 No. 6

IN THIS ISSUE



RMA CONVENTION AT CHICAGO
THE VARIABLE-MU TUBE AND DISTOR-
TION IN RADIO RECEIVERS

By A. G. Campbell

AMPLITUDE MODULATION VERSUS
FREQUENCY MODULATION

By Verne V. Gunsolley

MICROPHONIC DIFFICULTIES IN THE
SUPERHETERODYNE

By Rinaldo DeCola

DESIGN NOTES ON BEAT FREQUENCY
OSCILLATORS

By George A. Brueske

Sold only by subscription
\$2.00 per year



The Journal of the Radio Industry

JUN 3 1

Instant recovery of vacuum *minimizes shrinkage*

in high speed production

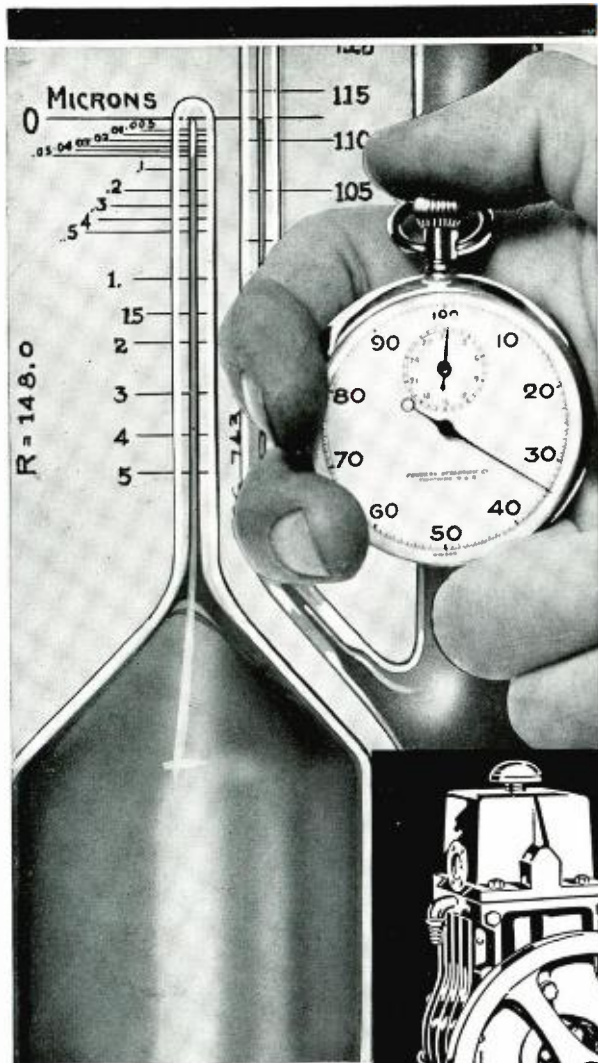

A McLeod gage and stopwatch will select pumps for your automatic machines more accurately than any specification talk. For speed, high vacuum and reliability, such a test invariably selects



● You can't stop production to wait for slow pumps to recover and you can't get good tubes while your vacuum lags. Hence production shrinks. But you can use pumps that recover instantly. Cenco HYPERVACS take hold quickly and wipe out those costly minutes of uncertain pressure. They standardize the vacuum factor in production. Also, by their working pressure of 0.05 micron, Hypervacs

put an extra margin of safety in your schedule. They not only come back faster... but exhaust better. That is no small factor in longer tube life. Then too, their ample volume capacity handles roughing as well as finishing. No pumps other than Hypervacs are necessary for complete exhaustion. This means economy and simplification of equipment

That Cenco HYPERVAC pumps cut tube costs and raise quality of product is being repeatedly proved in laboratories and confirmed in plants. You cannot afford to overlook the competitive seriousness of these facts. For details address, the Central Scientific Company, 460 East Ohio Street, Chicago.

Cenco *Hypervac* Pumps

CENTRAL SCIENTIFIC COMPANY
CENCO HIGH VACUUM PUMPS
 Hyvac Megavac Super vac Rotovac Hypervac
 NEW YORK - BOSTON - CHICAGO - TORONTO - LOS ANGELES

—one after another
SUCCESSFUL *Radio Manufacturers*
 have adopted the
SPRAGUE
Electrolytic **CONDENSER**

The contributions of the Sprague Specialties Company to the Radio industry have long been accepted as authentic improvements. Whether in the field of paper or electrolytic condensers, each Sprague product has been based upon careful engineering, originality in conception and design, full appreciation of the receiver manufacturer's problems and superb, modern manufacturing facilities. It is a tribute to research, engineering, manufacturing excellence and unqualified uniformity of Sprague products, that the new Sprague electrolytic condenser is now specified as standard equipment in many of the leading radio lines produced in this country. Successful radio manufacturers have created a situation which establishes the Sprague electrolytic condenser as the *standard of the industry!*

Illustrated booklet, diagrams, etc., furnished upon request

SPRAGUE SPECIALTIES COMPANY
 NORTH ADAMS, MASS.

Metal enclosed vent

One hole mounting

Small space—high capacity

One piece anode

Can—dull nickel finish

High voltage—self healing



RADIO ENGINEERING

Reg. U. S. Patent Office

Member, Audit Bureau of Circulations

Western Editor
ULMER G. TURNER

Editor
DONALD McNICOL

Managing Editor
F. WALEN

Vol. XI

JUNE, 1931

Number 6

Contents

	PAGE
EDITORIAL	4
IMPRESSIONS AND EXPRESSIONS <i>By Austin C. Lescarbours</i>	24
THE R.M.A. CONVENTION AT CHICAGO	27
THE VARIABLE-MU TUBE AND DISTORTION IN RADIO RECEIVERS..... <i>By A. G. Campbell</i>	29
A RADIO RECEIVER FOR POLICE SERVICE <i>By Virgil M. Graham</i>	31
A CAPACITY, INDUCTANCE AND IMPEDANCE CONVERSION CHART..... <i>By H. W. Anderson</i>	32
AMPLITUDE MODULATION VERSUS FREQUENCY MODU- LATION..... <i>By Verne V. Gunsolley</i>	33
INSTALLATION OF RADIO RECEIVERS IN THE HOME <i>By M. Asch</i>	36
THE DESIGN AND CONSTRUCTION OF STANDARD SIGNAL GENERATORS.... <i>By C. J. Franks and Malcolm Ferris</i>	37
MICROPHONIC DIFFICULTIES IN THE SUPERHETERODYNE <i>By Rinaldo DeCola</i>	45
TYPICAL PUBLIC-ADDRESS INSTALLATIONS <i>By Henry L. Williams</i>	47
THE PROPERTIES OF INSULATORS. . <i>By Edward Lupton</i>	50
DESIGN NOTES ON BEAT FREQUENCY OSCILLATORS <i>By George A. Brueske</i>	56
I. R. E. CONVENTION AT CHICAGO.....	60

Departments

NEWS OF THE INDUSTRY.....	62
NEW DEVELOPMENTS OF THE MONTH.....	66
INDEX OF ADVERTISERS.....	82

A STRONG TUBE GROUP

LATE in May it was announced that a consolidation had taken place which brought together in one manufacturing organization the Sylvania Products Company and the Nilco Lamp Works, Inc., both of Emporium, Penna., and the Hygrade Lamp Company of Salem, Mass.

Combined sales of these companies amounted to approximately \$9,000,000 for the year 1930. The Emporium and Salem units each manufactures incandescent lamp bulbs and radio tubes. The electric lamp bulbs are manufactured and sold under a license agreement with the General Electric Company. The Sylvania Products Company and Nilco Lamp Works, Inc., together do about the same volume of business as the Hygrade Lamp Company. Both the Sylvania and Hygrade brands are widely known and accepted in the fields in which they operate.

In view of the similarity of product, it is natural that negotiations which have extended over some period should terminate in this combination. The combined company will be the largest so-called "independent" manufacturer of electric lamp bulbs and radio tubes, and the economies of this combination should result in more efficient service to consumers of these products.

This consolidation will be effected without resorting to additional public financing. No new management or financial interests are involved in this consolidation and those officers who have been in charge of the separate businesses will continue with the new combination. No change is contemplated in the manufacturing facilities or locations.

BRYAN S. DAVIS
President

JAS. A. WALKER
Secretary

Published Monthly by

Bryan Davis Publishing Co., Inc.
52 Vanderbilt Ave.
New York City

E. M. BACON
Advertising Manager

J. E. NIELSEN
Circulation Manager

Publication Office—North Broadway, Albany, New York
Chicago Office—333 N. Michigan Ave.—Charles H. Farrell, Mgr.
St. Louis Office—505 Star Building—F. J. Wright

Kansas City Office—306 Coca Cola Building—R. W. Mitchell
San Francisco Office—155 Sansome St.—R. J. Birch
Los Angeles Office—846 S. Broadway—R. J. Birch

Entered as second class matter at the post office at Albany, N. Y., January 9, 1925, under the act of March 3, 1879. Yearly subscription rate \$2.00 in U. S. and Canada; \$3.00 in foreign countries.

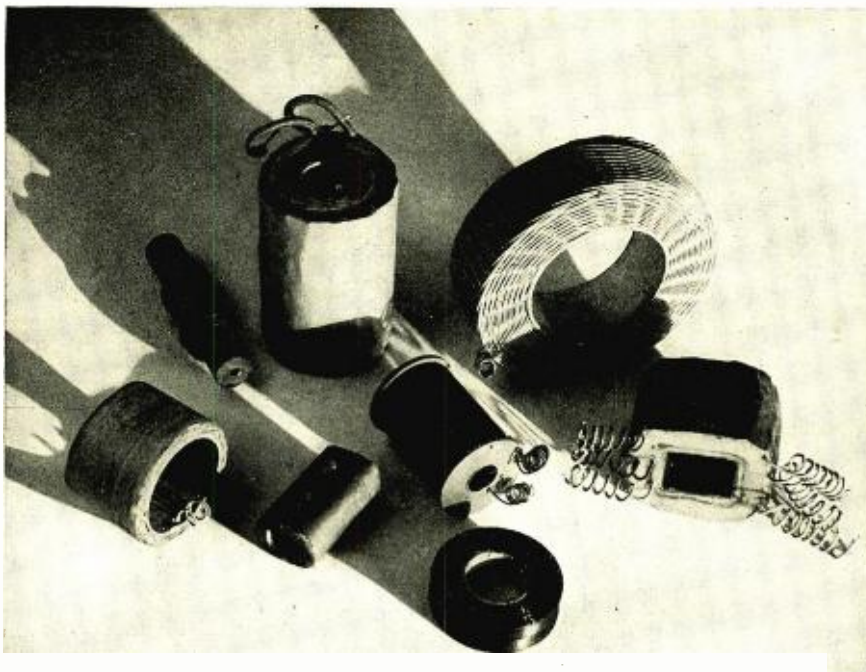

These coils, made to exacting specifications, are typical of the production in Anaconda's Coil Department at Muskegon, Mich.

Anaconda Coils— *for* DEPENDABILITY!

Radio engineers know from experience that they can rely on Anaconda Coils *always*. Their dependable performance has earned favor throughout the radio industry.

This dependability is due not only to advanced principles of design, but also to watch-making accuracy in construction. Up-to-the-minute manufacturing methods and equipment . . . and a series of most exhaustive tests . . . give Anaconda Coils unsurpassed high quality and uniformity.

There are Anaconda Coils . . . each one wound with Anaconda Magnet Wire, of course . . . for every purpose in radio. Let us tell you about them in full detail.



ANACONDA WIRE & CABLE COMPANY

GENERAL OFFICES: 25 BROADWAY, NEW YORK

CHICAGO OFFICE: 20 NORTH WACKER DRIVE

Sales Offices in Principal Cities

Magnet Wire Mills at Muskegon, Mich., Anderson, Ind., and Sycamore, Ill.

E d i t o r i a l

JUNE, 1931

COMMUNITY RADIO

THERE is at least an indication of a current trend of thought with regard to broadcasting facilities and services contained in an application received recently by the Federal Radio Commission. A corporation to be known as Community Radio calls for reallocation of 25 of the present 96 broadcast channels having 10 kc. separations—a total of 250 kc., so that 267 communities of above 10,000 population may be provided with organized local service.

It is suggested that the 25 adjacent channels be subdivided to provide 125 adjacent community channels having a 2 kc. separation, the power to range from 10 to 100 watts. Placement might be either 500-880 or 1250-1500 kc.

At a time when the Commission is being pressed for authorization of higher transmitting powers for certain cleared channel stations so that these stations may extend their circles of coverage, it is interesting to note the growing demand for purely local stations.

It was obvious that as the art grew there would develop a need for local stations offering services, other than entertainment, for which there may be public demand.

RECORD COMMUNICATION

LONG experienced telegraph executives and engineers are interested observers of the progress made by executives and engineers reared in the telephone business in continuing telegraph service as a dividend paying business.

The International Telephone and Telegraph Corporation now operates the land lines of the Postal Telegraph Cable Company; the submarine lines of the Commercial Cable Company, and All America Cables.

A realization of the fundamental difference between telephone and telegraph communication is indicated by the International's designation of telegraph service as "Record Communication."

TRAINING SERVICEMEN

THE Radio Dealers' Association of Union County, New Jersey, has taken a forward step toward improvement in receiver servicing. The Elizabeth, N. J., Vocational School at the request of the Radio Dealers' Association will inaugurate courses in radio servicing work for senior and for junior servicemen who during the day time are

employed by radio dealers doing business in Union County.

The purpose of the course is to better fit the men for their duties and in turn render to the public more efficient radio repair and installation services.

An Advisory Committee of three members of the dealers' association is cooperating with the director of the Vocational School in setting up the curriculum for the course.

Mr. Ralph E. Roe, secretary of the dealers' association, states that the course will include elementary electrical and radio principles, circuit tracing, trouble analyses, receiver installation, tube testing, servicing ethics, etc.

Organized service courses of this nature are of benefit to men whose experiences have been practical rather than theoretical. Also, men who have taken or who are taking correspondence courses will find the practical application of knowledge a material aid in their studies.

MANUFACTURERS' PARTS REQUIREMENTS

LIKE Joseph's coat of many hues, the modern radio receiver has many parts. The manufacturers of parts are in these days of hustling for business subjected to an aggravation of conditions which obtain always except when the supply is less than the demand.

We refer to the practice of requiring parts manufacturers to produce and submit samples to specification—often several samples—at shop cost or no charge, later submitting selected samples to other manufacturers for price quotations.

It would seem that the manufacturer who makes a nominal, non-profit charge for samples which meet the requirements, should be given a break in quoting competitively with other manufacturers who have been to no expense whatever in producing the samples. In fairness the company making up the selected sample parts should be granted a margin on their bid to help defray the cost of sample makeup. Either this or other bidders should be required to include in their bids the cost of the makeup of the samples—this amount to be credited to the maker of the sample in reimbursement.

Plainly, here we have one of the ills of modern industry, and one that organization should be able to cure.

Donald Mc Nicol

Editor.

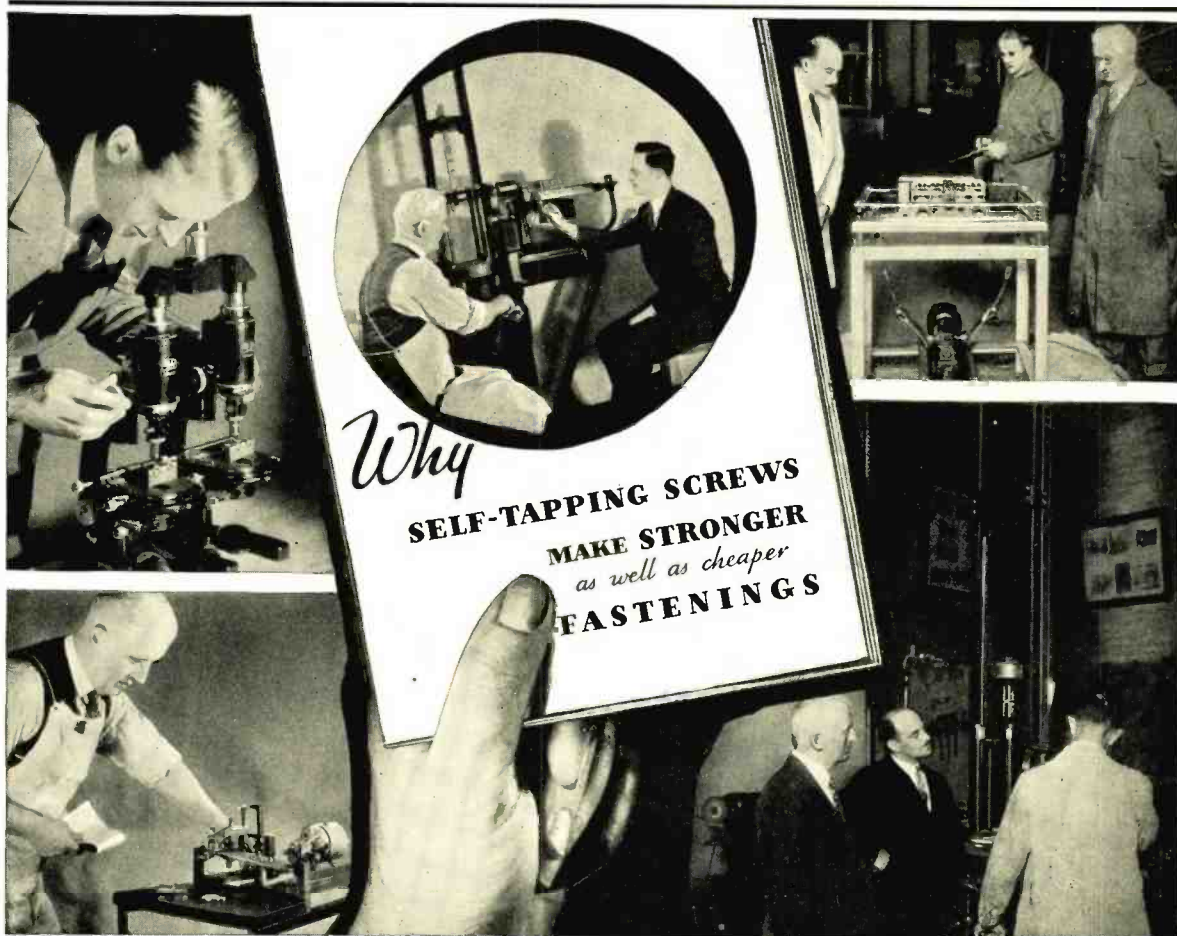

In this *FREE BOOK*... Scientists tell which fastening device holds best!

FOR weeks scientists of the College of Engineering, New York University, tested the holding power of fastening devices to determine whether Self-tapping Screws, noted for economy in assembly work, have greater or less holding power than the fastening devices they usually replace.

The investigation was unbiased and thorough. It developed much new data on the holding power of fastening devices under tension, shear and vibration stresses. All of the information is given

in the free booklet offered here. It is illustrated with photographs and charts; and also gives a scientific explanation of why fastenings made with Self-tapping Screws are more secure.

Every design and production man will find this book interesting and informative. Simply mail the coupon below. With it we will send, free, another valuable booklet which shows how leaders in the metal working industry are effecting important savings in the assembly of their products.

PARKER-KALON *Hardened* Self-tapping Screws

PAT. IN U. S. AND FOREIGN COUNTRIES

PARKER-KALON CORPORATION, Dept. L., 190-198 Varick Street, New York, N. Y.

Send me the free Security Booklet. Also free book of assembly economies.

Name and Co.

Address.....



Hygrade gives you this latest development in improved tube construction



Fortified Against Breakage

This sketch of the latest Hygrade 280 (patent applied for) shows the mica spreader (A) holding the plates in positive proper alignment and (B) keeping the filament in proper position in relation to the plate.



What Happens to Old Style Tubes

A severe jolt and sometimes a light impact can destroy the effectiveness of old type tubes. Many a set maker has encountered this danger, especially in shipping tubes installed in the set. Hygrade ends this loss through breakage by supplying the fortified tube.

FORTIFIED TUBES BRACED AT STRATEGIC POINTS

THE illustrations show why it is that Hygrade Tubes can stand the jolts and jars of delivery *in the set* without danger of inoperation or distorted reception. Vibration and rough handling cannot interfere with the space relation of the elements because they are braced top and bottom. Hygrade, supplying fresh, latest design tubes, offers to set makers the immediate advantage of fortified construction.

Hygrade facilities permit the economies of quantity production without sacrificing uniformity or quality. New developments constantly growing out of our engineering research are instantly passed along to the customer, for our inventory is small, assuring the buyer of fresh tubes of latest improved design.

HYGRADE RADIO TUBES

"Tubes You  Can Trust"

Made by HYGRADE LAMP CO., of Salem, Massachusetts, Makers of Hygrade Lamp Bulbs for Over 30 Years



Announcing Tung-Sol Balanced Unit Electrolytic Condenser

THE manufacturing precision and engineering skill which for years have been identified with the name Tung-Sol, immediately stamp this Tung-Sol condenser as a high class, reliable and mechanically perfect product.

The Tung-Sol Balanced Unit Electrolytic Condenser meets price as well as engineering tolerances. We will gladly submit samples and prices.

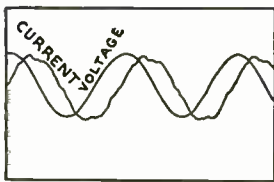

Oscillogram showing power factor room temperature.

Characteristic curve chart (at right)

The following are characteristics of Tung-Sol Electrolytic Condenser at 140° F (average operating temperature of modern radio sets). Leakage current per 8 M. F. .85 M. A. Power factor 15%. Capacity 8.35 M. F.

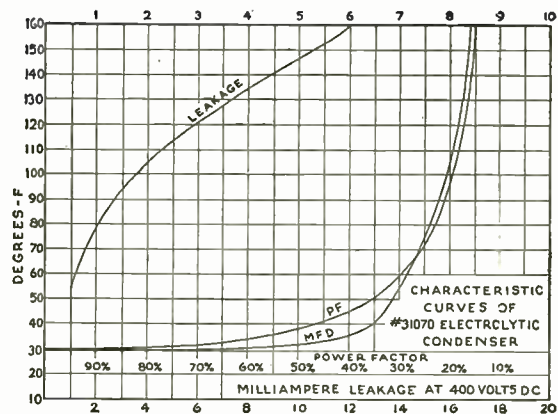

TUNG-SOL CONDENSERS INC., Chicago, Illinois

Division of TUNG-SOL LAMP WORKS INC., Newark, New Jersey

Manufacturer TUNG-SOL RADIO TUBES

THE ONLY THING NEW IN RADIO

SILENT AUTOMATIC TUNING VISUAL STATION & TONE INDICATION

made possible by

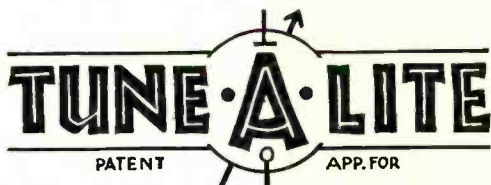

Automatic volume control in radio sets is unquestionably a distinct improvement, yet in many instances it has proved a liability because of a seeming loss of selectivity and the apparently high noise level which it introduces.

A new type of gas filled tube developed by Duovac in conjunction with a simple novel circuit designed by Professor Alexander Senauke, eliminates these disadvantages and permits full appreciation of the real merits of automatic volume control.

Silent tuning is now possible. Every audible station on dial can be brought in unerringly even though the volume control is turned down to a point where not a sound issues from the speaker. Extraneous noises, static and other electric disturbances will not actuate the light column.

Circuit modifications for adopting TUNE-A-LITE are slight. The economies effected in power pack design through the use of TUNE-A-LITE, more than make up the cost of the tube and of additional equipment.

Manufactured by the makers of

DUOVAC

***The Precision Radio Tube**

DUOVAC RADIO TUBE CORP.
360 FURMAN STREET, BROOKLYN, N. Y.

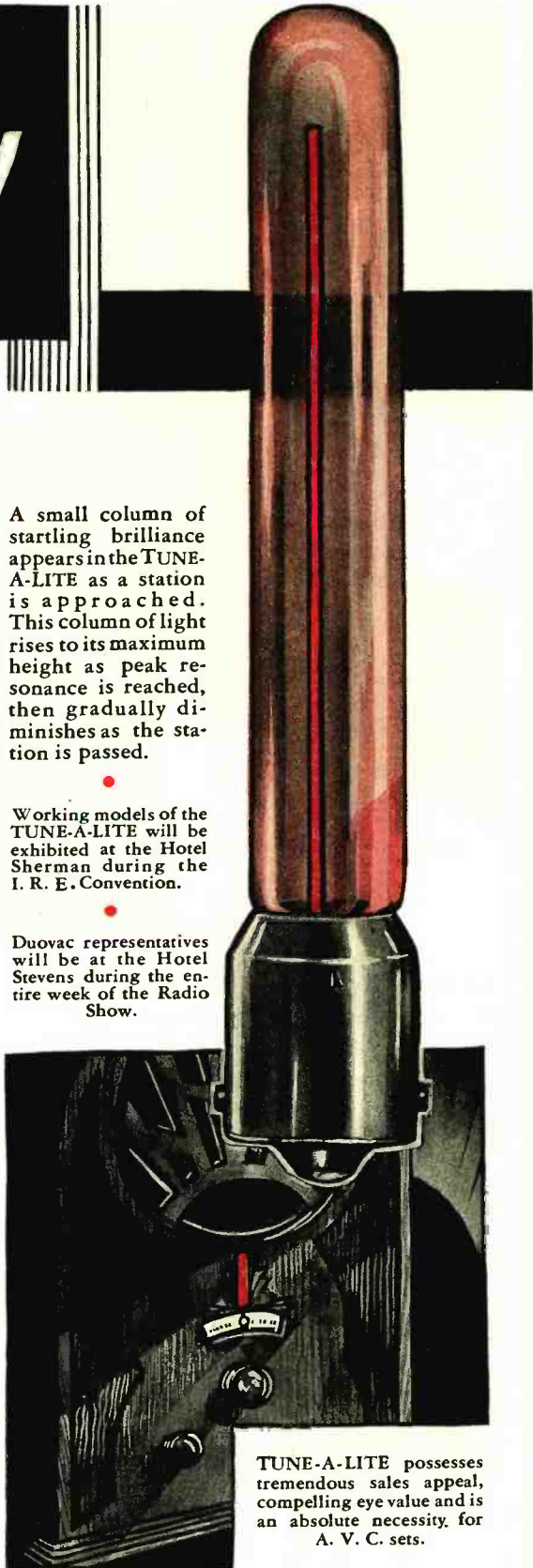

A small column of startling brilliance appears in the TUNE-A-LITE as a station is approached. This column of light rises to its maximum height as peak resonance is reached, then gradually diminishes as the station is passed.

Working models of the TUNE-A-LITE will be exhibited at the Hotel Sherman during the I. R. E. Convention.

Duovac representatives will be at the Hotel Stevens during the entire week of the Radio Show.

TUNE-A-LITE possesses tremendous sales appeal, compelling eye value and is an absolute necessity for A. V. C. sets.

ADAPTABILITY

The Incas' ability to adapt themselves to the difficulties of the Peruvian terrain is only one instance of their indomitable racial character. To build such a terraced farm as illustrated required the laying of nearly 700 perches of stone and the handling of nearly 5,000 tons of soil for each acre reclaimed.



The ability to adapt one's product to the ever-changing trends of design is a real consideration when the manufacturer in the radio industry is selecting his source of supply for coils.

Inca's position is unique. With the latest equipment in the industry, with an experience that only pioneers can acquire, with research and engineering facilities second to none . . . Inca is leading, not merely following the progress of the radio industry . . . particularly wherever a coil is involved.

Each change in radio design finds Inca prepared. Each change finds Inca's customers secure from the uncertainty of unauthoritative or obsolete coil design.

Inca enameled wire makes well designed coils still better . . . because no coil can be better than the wire in its windings.

INCA MANUFACTURING DIVISION



Symbolic of the best in copper wire products.

Eastern Office: 233 Broadway, New York, N. Y.

Western Office: 1547 Venice Blvd., Los Angeles, Calif.

of NATIONAL ELECTRIC PRODUCTS CORPORATION
FORT WAYNE, INDIANA





GILBY A **DEPENDABLE** SOURCE FOR TUBE MATERIALS *and electrical resistance alloy products*

FILAMENT. Our Engineering and Production Departments in strict co-operation with developments and accomplishments, have won the confidence of the Radio Tube Industry for supply of Radio Tube Filaments. This was brought about by absolute control of material, by successfully meeting rigid specifications, and by duplicating laboratory developments in actual production.

GRID PLATE AND OTHER MATERIALS. GILBY WIRE COMPANY can supply pure nickel and various alloys for the correct working of these parts. GILGRID No. 40, which is a new grid wire, is the latest development for the improved grid.

MESH. GILBY SELVAGE MESH and plain mesh are long time standards.

CARBONIZED NICKEL. GILBY WIRE COMPANY has been a reliable source for uniform and improved carbonized nickel sheet and mesh. We will co-operate with your Engineering Department in developing the proper carbonized material for your product.

RESISTANCE MATERIALS. As in Radio products, GILBY WIRE COMPANY'S Engineering and Production Departments have accomplished real things in the improvement of resistance materials in nickel-chrome, copper-nickel and allied materials.

ENGINEERING DEPARTMENT. GILBY WIRE COMPANY'S Engineering Department is our contribution to the industry in that we are developing new products, improving processes continuously in order to meet requirements of the Radio and Electrical industries in these days of over night demand for new and better materials. Our methods conform to most rigid specifications, thereby cutting down shrinkage, so essential in the present business world. Specify GILBY products, and your production costs will be reduced.

Manufacturers of
Filament
Grid Materials
Plate Materials
Nickel Wire and Sheet
Nickel Mesh—plain and
selvage
Carbonized Nickel Sheet
and Mesh
Nickel Chrome Alloys
Nickel Copper Alloys
Manganin
These materials in wire
and sheet form, covered
with cotton, silk and
enamel.



GILBY WIRE COMPANY

Wilbur B. Driver, President

NEWARK, NEW JERSEY



Sockets or mousetraps

"If a man write a better book, preach a better sermon or make a better mousetrap than his neighbor,—though he build his house in the woods—the world will make a beaten path to his door."

—Emerson.

Substitute the word "Socket" for "Mousetrap" and you have the CRC picture!

. . . . Beloit, Wisconsin, is far enough from the centers of Radio Set production to justify the phrase "in the woods."

. . . . Yet — CRC Sockets—made in Beloit—are a vital part of receivers manufactured in every civilized country on the face of the globe.

. . . . From England • Australia • Sweden • Siam • South Africa • China • Japan • South America • France • come orders—figuratively "making a beaten path to our door."

. . . . In 1930, CRC made and sold more sockets than ever before in its history.

. . . . The reason?

. . . . CRC Sockets are better Sockets!



CENTRAL RADIO CORPORATION
Beloit .. Wisconsin

Representatives—

R. C. JAMES & CO. Seattle, Washington
PAUL R. BUEHLER . . . 406 Harris Building, Los Angeles
A. C. SIMMONDS, 218 Front St., Toronto, Ontario, Can.

SEE AEROVOX EXHIBIT AT RMA TRADE SHOW—BOOTH NO. 94

AEROVOX

The Most Complete Line of Screw Mounting DRY Electrolytic Condensers in the Radio and Electrical Industries

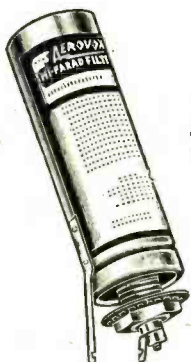

Type GA Grounded Can

Dimensions—1 3/4" x 5" Overall. Available in capacities up to 8 mfd. in the 500-volt ratings and higher capacities in lower voltage ratings.



Type GE Grounded Can

Maximum capacity in 500-volt rating—8 mfd.

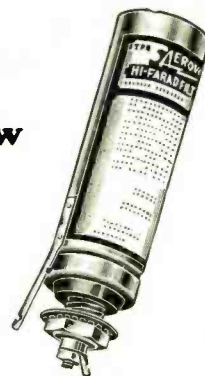

Type IA Insulated Can

Dimensions—1 3/4" x 5 1/4" Overall. Available in capacities up to 8 mfd. in the 500-volt rating and higher capacities in lower voltage ratings.

Available in a wide variety of sizes, capacities, voltage characteristics and mounting features. These units are Dry, Low in Cost per Microfarad per Volt Rating, Low in Leakage, Compact, Light in Weight, Safe, Surge-Proof, Self-Healing, and provide Long Life, Stable Operation and High Filtering Efficiency. They may be mounted in any position—Upright, Inverted, Horizontal or at any other angle.

Compact, Efficient and Reliable Condensers for Many Purposes



Type 1465.

Another new midget mica condenser is the Type 1462 shown at the right. Available in capacities up to .006 mfd.



Type 1462.

A new extra small size mica condenser available in capacities up to .0005 mfd., rated at 500 d.c. volts rest voltage and 250 d.c. working voltage. Especially adapted for use in very small spaces.



Type 1120.

A heat resisting, leakproof condenser especially adapted for use in automobile radios and other applications where high temperatures are encountered.



Type 280.

A compact condenser made to meet manufacturers' requirements for an all-around efficient, high quality and low cost condenser. These units are hermetically sealed in special tubes and provided with wire leads.

Send for Complete Catalog

Complete specifications of all AeroVox units, including insulation specifications of condensers, carrying capacities of resistors and all physical dimensions, electrical characteristics and list prices of condensers and resistors, are contained in a complete 40-page 1931 Condenser and Resistor Manual and Catalog sent free on request.

FREE!

A copy of a 32-page book, containing a wealth of information on all types of electrolytic condensers will be sent free of charge on request. Just check "The Hi-Farad Electrolytic Condenser" on the accompanying coupon.

AEROVOX
WIRELESS CORP.
70 WASHINGTON ST.,
BROOKLYN, N.Y.



Ask for The AeroVox Research Worker

The AeroVox Research Worker is a free monthly publication that will keep you abreast of the latest developments in radio. Your name will be put on the mailing list free of charge on request. Simply check and mail the accompanying coupon.

Check and Mail This Coupon

AEROVOX WIRELESS CORP. Radio Engineering,
70 Washington St. June, 1931.
Brooklyn, N. Y.

Gentlemen:

- Please send me without charge or obligation:
 Your 40-page Condenser and Resistor Manual and Catalogue.
 The Research Worker.
 The Hi-Farad Electrolytic Condenser.

Name

Street

City..... State.....

NEW SPEED TUBES

FOR THE NEW RECEIVERS...

VARI-MU and PENTODE

NEW !!

- 247—PENTODE
- 233—PENTODE (2 Volt) D.C.
- 235—VARI-MU SCREEN GRID
- 551—VARI-MU SCREEN GRID
- 236—SCREEN GRID (6 Volt) for D.C. or Auto sets
- 237—DET-AMP. (6 Volt) for D.C. or Auto sets
- 238—PENTODE (6 Volt) for D.C. or Auto sets



SPEED TYPE 235



SPEED TYPE 551



SPEED TYPE 247

NEW !!

FOTO-LECTRIC TUBES

Caesium Gas Filled Type
(Red Sensitive)

*Numerous types, for
All Standard Equipment*

NEW !!

Products
Quotations
Sales Plans
Adjustment Policy

*Write for details or get them
at the Cable Booth at the
R.M.A. Trade Show.*

CABLE RADIO TUBE CORP.
230-242 NORTH 9TH STREET
BROOKLYN, NEW YORK

R.M.A. Trade Show
Booths 72-73
Ball Room
Stevens Hotel, Chicago



Hotel Headquarters
2118A, 2119A, 2120A
Stevens Hotel,
Chicago

DeJur-Amsco

Fine Products for Ten Years

MANUFACTURER OF RELIABLE RADIO PARTS

DeJur-Amsco products range from the tuning essentials to accessories. Our tuning condensers are highly efficient and are made in a variety of electrical and mechanical designs. Our special oscillator tracking condenser simplifies single control superheterodyne design and eliminates the expensive and unsatisfactory padding arrangements. Also for superheterodynes, are our Transitors—high gain intermediate frequency amplifying transformers, made in four types, meeting every I-F requirement. DeJur-Amsco rheostats and potentiometers are noted for their sturdy construction and longevity. They are manufactured in a wide range of ohmages and power ratings and find a universal application in electrical and radio fields. The DeJur-Amsco Varitor is a small semi-fixed condenser, that answers several requirements in the modern receiver. Our dials, friction drive, direct drive, full vision, sector vision, and escutcheons, are accessories that contribute the final touch of beauty comparable in their own way to the electrical efficiency of our more fundamental parts. DeJur-Amsco parts are engineered in our own research laboratories, and ten years of successful experience in meeting the needs of the manufacturer insure their adaptability to your own requirements.

VARIABLE CONDENSERS

TRANSITORS

(High Gain I-F Transformers)

RHEOSTATS

POTENTIOMETERS

POWER RHEOSTATS

(For Heavy Duty Work)

ESCUTCHEONS

DIALS

VARITORS

(Small Semi-Fixed Condensers)

PILOT LIGHTS

BINDING POSTS

CONNECTION STRIPS

Write for literature describing the complete line of DeJur-Amsco Radio Manufacturers' parts

DeJur-Amsco CORPORATION

95 Morton Street, New York

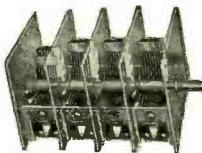

No Other Electrolytic Condenser Gives You All These Features!

SPECIFY ACRACON[®] AND GET THE BEST

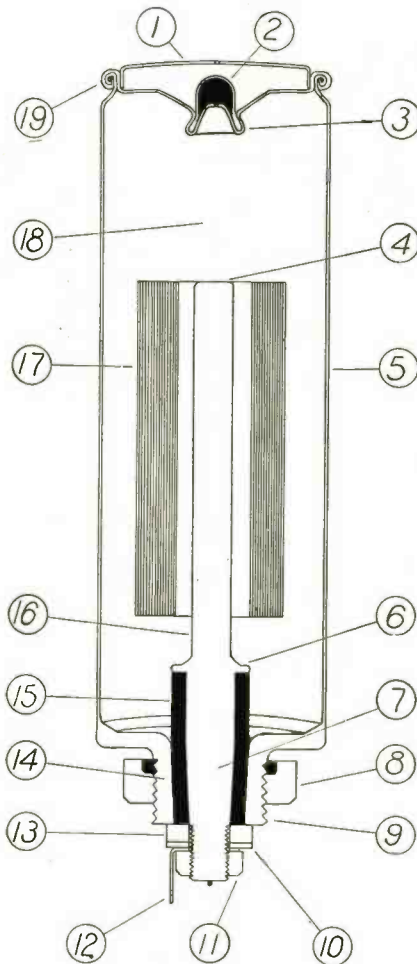

ONE glance at the illustration shows 19 reasons that will convince any engineer of Acracon's superior construction.

- | | |
|---|---|
| <ol style="list-style-type: none"> 1. Metal cover for protection and appearance. 2. Live, rubber nipple. 3. Nipple spun into aluminum shell. Absolutely leak-proof. 4. Anode spiral cold welded into anode, giving rigid construction. 5. One piece extruded aluminum container. 6. Retaining flange for rubber gasket. 7. Tapered anode stem for snug fit. 8. Large cadmium plated steel mounting nut, concave to insure tight connection. 9. 3/4\"-16 thread neck for mounting. 10. Metal washer. | <ol style="list-style-type: none"> 11. Anode nut. 12. Anode soldering tab. 13. Large size insulating washer. 14. Tapered hole to take tapered anode. 15. Special live, rubber insulating gasket free from impurities. 16. Heavy, rigid, anode stem of high purity aluminum. 17. High purity anode, spiral, so wound as to eliminate the necessity of insulating liner between anode and container. 18. Special, high, critical voltage electrolyte, well over anode to insure long life. 19. Leak-proof rolled seam as used in canning industry. |
|---|---|

Exhaustive laboratory tests by many leading engineers have proved Acracon's electrical efficiency. Yet the Acracon electrolytic costs no more than other makes.

The Acracon unit is now available in capacities up to 16 microfarads at either 440 or 475 volt peak in the single anode type.

If you are not already specifying Acracon, write today and learn first hand why Acracon is fast becoming the choice of the industry.

* All Acracon Features Are Protected by Patents Pending.

CONDENSER CORPORATION OF AMERICA

259-271 CORNELISON AVE.

JERSEY CITY, N. J.

Chicago
Cincinnati

Factory Representatives in:
St. Louis
San Francisco
and other Principal Cities

Los Angeles
Toronto

THE INVERTED TYPE (8 Mfd.)

ELKON NON-AQUEOUS HI-VOLT CONDENSER



The new Inverted Type 8 mfd. Elkon condenser meets the standard requirements for a unit to be used on sub-panel wiring jobs. It has the same outstanding characteristics as the other Elkon Non-Aqueous Hi-Volt Condensers which have been adopted as standard equipment by many leading set and instrument manufacturers.

- 1 **Highest Filtering Capacity** of any electrolytic condenser.
- 2 **Working Voltages**—up to 450 v., d. c., to meet the varied requirements of present radio sets.
- 3 **Absolutely Dry:** A condenser from which all free water is eliminated.
- 4 **Low Leakage:** Normal rated leakage 0.1 mil per mfd., after operating short period.
- 5 **Impervious to Low Temperatures:** Operates efficiently from minus 40° F to 125° F
- 6 **Long Life:** To reduce replacements and interrupted service periods to a minimum.
- 7 **Self Healing:** All surge voltage conditions encountered in properly designed sets have no detrimental effect on the Elkon condenser.
- 8 **Compactness:** Small cubical volume per microfarad.
- 9 **Stability in Operation:** To guard against mechanical and electrical variation that would affect action of the circuit.
- 10 **Low Cost Per Microfarad Per Voltage Rating.**

For Production Economy use the ELKON Condenser WITHOUT THE CAN!

Many manufacturers have substantially reduced their condenser costs by using Elkon condensers without the can. The illustration at the right shows how they can be mounted in the set.

The metal can is not necessary with Elkon condensers as each unit is enclosed in a sturdy, wax-dipped cardboard container providing ample protection for efficient operation.

Samples of Elkon condensers without the can in any capacity or combination of capacities will be sent to all recognized manufacturers.

Send for booklet giving complete technical data and general description.

ELKON DIVISION
P. R. Mallory & Company, Incorporated
Indianapolis, Indiana

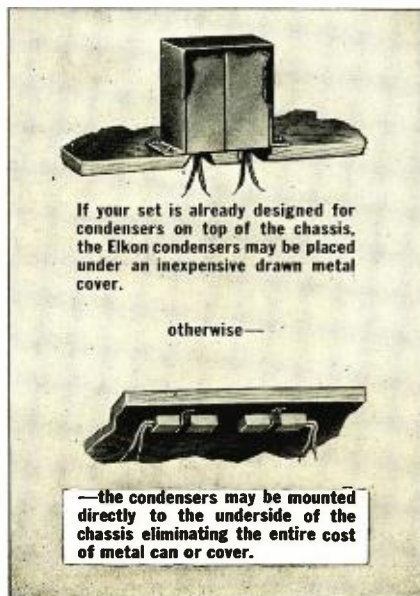

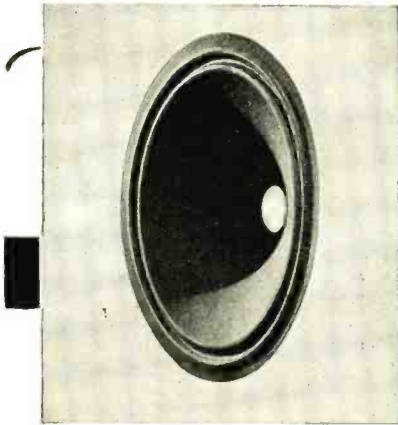

CROSELEY **MAGNAVOX** **Rola**
UTAH **Jensen** **Stromberg-Carlson**
ELECTRO-DYNAMIC SPEAKERS
AMERICAN BOSCH **LANSING** **OPERADIO**

The **HAWLEY HALL OF FAME**

STEWART-WARNER **PETER SMITH STAMPING**
COLONIAL Radio **BEST**
LA CROSSE RADIO
Boudette

Does Your Speaker Diaphragm Give Full Frequency Response?

Do you realize how much the weight, texture, and contour of a speaker diaphragm can change the performance of a radio receiver?

The research engineers of the Hawley acoustical laboratories have evolved a patented process of moulding one-piece diaphragms to meet the individual requirements of any unit. The gain in purity of tone and range of response is truly astonishing.

Hawley engineers are ready to demonstrate what Hawley Moulded Diaphragms can do for your speakers. Follow the example of world-famous radio manufacturers and adopt these remarkably efficient diaphragms for your units. The Hawley laboratories are at your service—and the Hawley plant can handle any diaphragm output that your schedules may demand, Let us quote you, today!

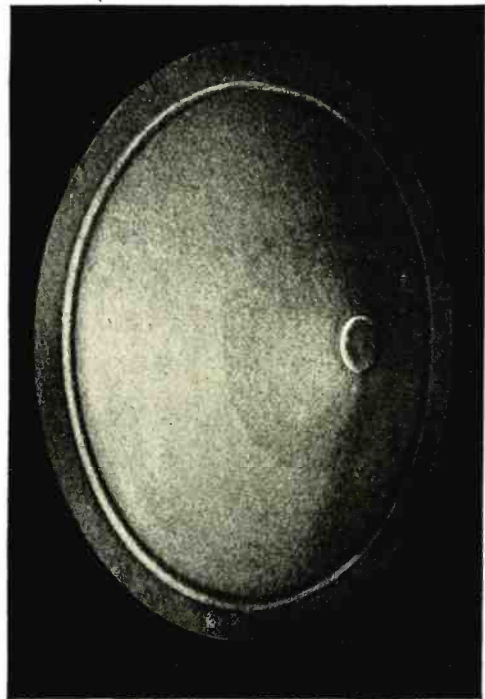

HAWLEY

MOULDED  DIAPHRAGMS

HAWLEY PRODUCTS COMPANY, 201 N. FIRST AVENUE, ST. CHARLES, ILLINOIS

R. M. A.

Booth No. 121

Radio Engineering congratulates the R.M.A. upon their fifth annual Trade Show and seventh annual convention and the I.R.E. upon the occasion of their sixth annual convention.

Radio Engineering headquarters from June 4th to June 13th will be at the Hotel Sherman.

Extra copies of the June issue will be available at the Sherman and at the Radio Engineering booths. Drop in!

Radio Engineering
Paid A.B.C. Circulation
(latest audited statement)
10,327

The closest competitor
(among electronic and
radio publications)
5,217

NOTE. The A.B.C. paid circulation of Radio Engineering is approximately *twice* that of any other radio (or electronic) publication — among the executives and engineers of the radio and associated industries.

I. R. E.

Booth No. 150

"I'm Smaller than other fellows----

But I do a MAN-SIZED JOB!"

I'VE been through an awful lot in the past few months. I've been tested and rebuilt and tested again until I'm tired of looking at Elkon engineers. . . . Just as I began to think I was perfect, they sent me out to a lot of other places where I was put through my paces again and again . . . Rather rough going for a long while but I guess it was all for the best because I know now that I'm ready to start out on my own . . . Thank heavens that I won't have to go back to those Elkon engineers again,—they're the testingest bunch I've ever met."



Small size and efficient operation are the outstanding characteristics of the Elkon Audio By-pass Condensers. They are covered with the same type of sturdy, wax-dipped cardboard carton which is being used so successfully on the standard Elkon Filter Condensers.

The following sizes can be supplied.

Capacity	Size	Voltage
¼ mfd	½ x ½ x 2	450
½ mfd	½ x ½ x 2	450
1 mfd	¾ x ¾ x 2	450
2 mfd	1 x 1 x 2	450
½ mfd	½ x ½ x 2	up to 150
1 mfd	½ x ½ x 2	up to 150
2 mfd	¾ x ¾ x 2	up to 150
4 mfd	1 x 1 x 2	up to 150
8 mfd	1 x 1 x 2	up to 150



A special mounting band for fastening condensers to the chassis can be supplied if desired.



That's his story—and he sticks to it! For our part we're rather proud of the job. The Elkon Audio By-pass Condensers are small, compact, efficient and economical,—with a life-expectancy in excess of the usual set requirements. That's just about the full line-up for an ideal audio by-pass condenser!

Samples will be sent upon request to all recognized manufacturers.

ELKON DIVISION

P. R. Mallory & Co., Incorporated

Indianapolis, Ind.

ELKON BY-PASS AUDIO CONDENSERS

Now MODEL F

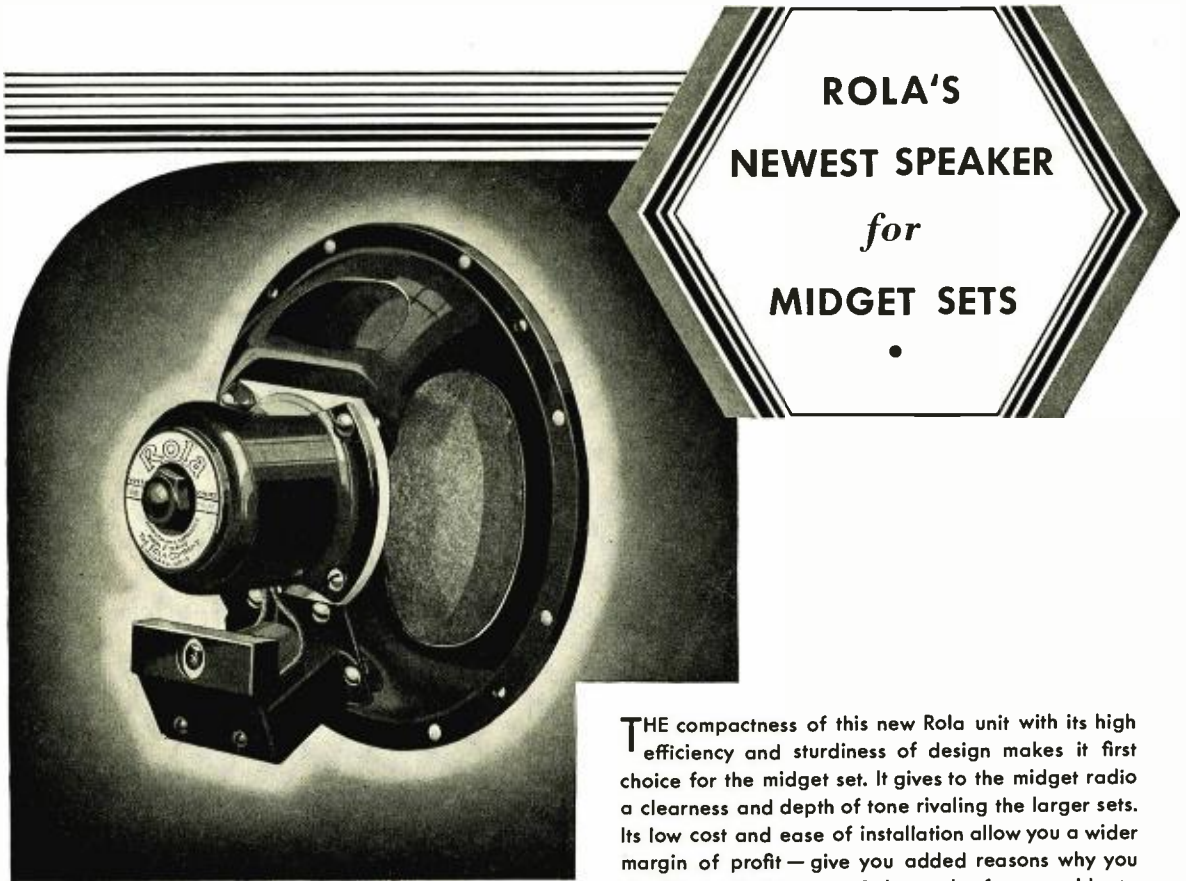

**ROLA'S
NEWEST SPEAKER
for
MIDGET SETS**

Visit the Rola exhibit at the R.M.A. Trade Show in Chicago, June 8-12. Booth B1-A in the Hotel Stevens Ballroom

THE compactness of this new Rola unit with its high efficiency and sturdiness of design makes it first choice for the midget set. It gives to the midget radio a clearness and depth of tone rivaling the larger sets. Its low cost and ease of installation allow you a wider margin of profit — give you added reasons why you should specify this newest Rola speaker for your midgets.

Rola Speakers have continually demonstrated their unequaled ability to perform well. A product of specialization, built in a plant devoted to loud speakers exclusively, these speakers have won the confidence of outstanding radio engineers and manufacturers. More than a million units now in use testify to their dependability. Full particulars concerning the entire Rola line is now at your disposal. Write today!

**ROLA
SPEAKERS**

*for better
Radio Reception*

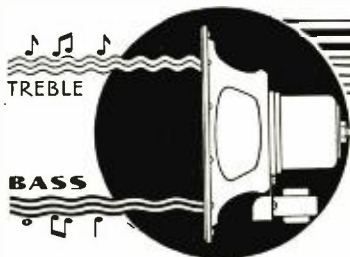

THE ROLA COMPANY
2570 Superior Ave. Cleveland, Ohio

Manufacturers of Loud Speaker Units for Midget . . . Automobile and Console Sets . . . Also high power Loud Speakers for Public Address Systems and Talking Pictures.

For Full Benefits of Transformer Knowledge

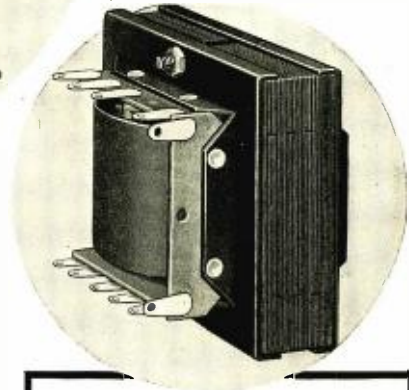
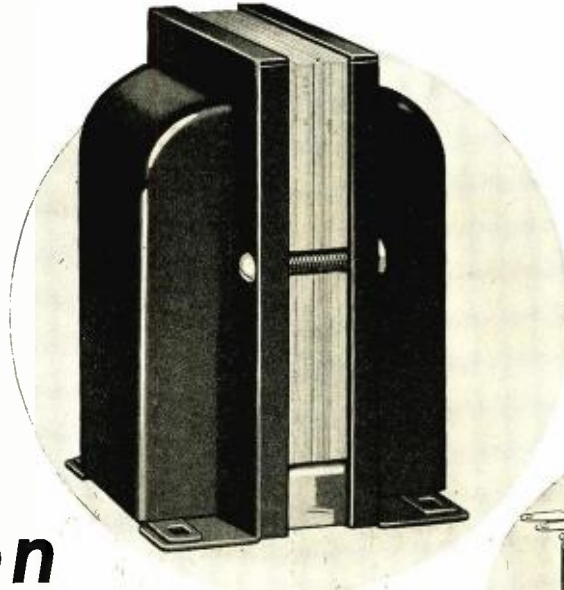

Call on JEFFERSON

SINCE such a large "slice" of the satisfaction your radio gives depends upon the transformer you use, make sure you receive full value for every dollar you pay out.

The small transformer has always been Jefferson's particular field . . . and in this field it has acquired a worthy and sound reputation built on performance, and by word of mouth wherever engineers get together.

Tap a good job of transformer design—and you usually find Jefferson had a hand in it. Trace a manufacturing activity back to its roots and you usually find Jefferson pioneering a genuine step forward when that advance was needed.

Such is the story of Jefferson's activities in the radio-, the oil-burner-, the Neon-sign-transformer fields. Development after development can be pointed to—as the achievement of Jefferson engineers, and, first in the field with a practical radio transformer, Jefferson has also kept a step ahead of current engineering thought in every transformer it makes.

Because Jefferson operation is standardized, the small manufacturer, as well as the large, reaps every benefit of Jefferson's experience and Jefferson's wide contact. Those benefits include a surprisingly satisfactory price. Let us know what your specifications and requirements are. There is no obligation.

**You Receive From
JEFFERSON**

An experience which includes every small-transformer problem and development of radio.

Engineering ability which has pioneered many of today's taken-for-granted improvements.

A wide and thorough grasp of the field including not only today's problems but those of tomorrow.

Adequate manufacturing facilities—a variety of standard Jefferson transformers to choose from to meet your exact requirements.

JEFFERSON ELECTRIC COMPANY

1599 South Laflin Street, Chicago, Illinois

A permanent magnet dynamic



Jensen research scores again! The new Jensen PM-1 marks the most important advance in the radio industry since the introduction of the Jensen Electro-Dynamic. Its tone quality is electro-dynamic, yet it requires no field coil or separate power supply. It is particularly designed for use with battery operated sets and for hotel room and apartment installations. It is unusually compact and light in weight.

Jensen

NEW MODEL SPEAKERS

BIG in performance—compact in size. The new Jensen Model J-1, Concert Jr. Electro Dynamic Speaker, with 6-inch diameter (overall) cone, is designed to meet the latest requirements in set design. Its appearance is an absolute innovation in Electro-Dynamic Speaker Design. All connections completely enclosed. Actually hear this new speaker to convince yourself of its superiority over any other unit of comparable size. All of the new Jensen Speakers will be on display and demonstrated at the R. M. A. Trade Show, Stevens Hotel, Chicago. Literature mailed on request.

JENSEN RADIO MANUFACTURING COMPANY
6601 S. Laramie Ave., Chicago, Illinois



A new electro-dynamic

One responsibility for coils

From copper bar to finished product, every operation in the manufacture of coils is performed in General Cable plants. Complete responsibility for fabrication of coils rests upon General Cable.

Interpret that responsibility as broadly as you will. It embraces the maintenance of quality manufacture and the capacity to supply your needs for coils of any kind, in any quantity—quickly and dependably. It includes the tireless search for better coils—better magnet wire, better

methods of application—greater economy in production.

To effect such results General Cable marshals coil experience, manufacturing facilities, research laboratories, and personnel of an unusual character. Dudlo, Rome and the other organizations now part of General Cable supplement and strengthen each other.

One responsibility covering *all* factors, converges upon a single purpose—the assurance of unequalled satisfaction in the purchase and use of General Cable Coils for your products.

GENERAL CABLE CORPORATION

EXECUTIVE OFFICES: 420 LEXINGTON AVENUE, NEW YORK • OFFICES IN PRINCIPAL CITIES



Impressions and Expressions

By AUSTIN C. LESCARBOURA

ON TO CHICAGO

AS these lines are being written, the thoughts of the entire industry are centered on the forthcoming RMA Trade Show at Chicago. It seems good to have the big gathering once more in the Windy City, which is more conducive to good sound business than the balmy atmosphere of Atlantic City.

There will be less whoopee and more hard work at this show than the radio industry has yet witnessed. Of course there will be more of the "follow the leader" complex than ever before, for any student of the general radio situation knows that most manufacturers have been waiting for the show in order to formulate definite plans. While the original intention of the RMA Trade Show was to present the forthcoming season's offerings to the jobbing and retail trade, it has become increasingly apparent in late years that its main purpose today is to try and find out what competitors have up their sleeve, so as to formulate one's own plans.

We sometimes wonder whether or not the RMA Trade Show should be held in June. To our way of thinking, it might be better to hold the event in the spring, so as to get the season under way that much sooner. Or perhaps it might be better not to hold a show that tends to hold up definite plans until the last minute. Perhaps the industry would benefit from a policy of "no yearly models, but steady improvements and refinements," after the fashion of sound automobile merchandising principles.

KILLING THE GOOSE

IT is rumored and quite persistently that the greatest dumping party yet witnessed by an industry grown almost callous to dumping, is about to be held. The details are rather vague, but in a general way it seems that one organization with an inventory of 30,000,000 tubes or better is about to dispose of the entire stock at a ghastly low price, to a well-known dealer in distress merchandise.

We do not know whether the facts are as rumored. We do not even know whether this greatest of dumping parties will take place. But we do know that if such a dumping party does take place, it is going to have a disastrous and lasting effect on the welfare of the radio tube industry, so far as most tube manufacturers, limited to the production of receiving tubes only, are concerned.

Already certain department stores are selling radio tubes of reputable make at prices heretofore associated only with nondescript tubes and obvious rejects. If the dumping party above mentioned takes place, still lower prices for reputable tubes will become commonplace. If there are 30,000,000 tubes involved in the deal, at least half the year's market will probably be filled, leaving the balance to be served by a superabundance of tubes, resulting in violent price cuts. One thing is certain: the old goose will be definitely killed. There will be no golden eggs in this radio tube business for years to come. Many will pass out of the picture.

A big inventory is certainly bothersome, we must admit. But to dispose of the inventory at one fell swoop by unloading the tubes at a ridiculously low price is certainly no brilliant business move.

THE BIG KILLING

THOSE who would have us believe there is no money in the radio industry, have failed to give due thought to the legal gentlemen engaged in settling the disputes of our worthy brethren. The legal battles of the past have been as so much chicken feed compared with the millions and millions involved in present legal actions. Which makes one wonder what it is all about, and who is going to benefit out of this see-saw game of heads-you-win, tails-you-lose decisions as a given case progresses from one Court to the next.

We wonder just where the automobile industry would be if it followed the same practice as the radio industry. It appears that the automobile industry long ago decided upon sensible patent pooling, and that today the individual automobile manufacturer pays only a few dollars on each car for the patent rights required. If the individual automobile manufacturer had to pay 7½ per cent or be constantly in court, he would be quite unable to give the value and to make the profit now prevalent.

Sooner or later this industry of ours has got to get the patent situation settled. The settlement will call for a degree of sincerity that does not as yet exist among radio manufacturers. There will have to be genuine patents placed in the pool, rather than mere threats. There will have to be a fair royalty rate. There will have to be proper respect for all worthy patents, by the largest companies quite as well as the smallest. There will have to be less pussy-footing, so that patents of doubtful validity can be given the acid test in determining their genuine worth. We must come to some such pass before radio definitely emerges from the racket stage.

DIVERSIFY!

SOMEONE has said that the radio industry is geared to produce 25,000,000 radio sets per year and probably 250,000,000 radio tubes. Since those figures are just about five to ten times the capacity of the market even in its balmyest days, it becomes evident that we have too much plant and not enough salable product. We must diversify.

Your writer has the greatest respect for the opinions of Floyd Parsons, well-known industrial writer. Mr. Parsons has stated recently that one reason for the grand crash in business as a whole was the lack of initiative and diversity of products on the part of industrialists. Too many industrialists insisted on making the same thing, resulting in overloading the market which sagged and then broke.

You might as well learn that lesson now as any other time. If you have a big plant on your hands, which is ostensibly out of keeping with any demand you can expect for the next few years, there are just two courses of action: first, you can reduce the size of the plant by desperate measures, and they will be desperate, for it is almost impossible to dispose of plant space these days; secondly, and more logically, you can develop some new products through good engineering and research. Of course there are many new things yet to be introduced to a public that has never failed to respond to a fresh appeal.

AS OLD AS RADIO AS NEW AS TELEVISION

No other single organization offers as complete and diversified line of radio products as the DeForest Radio Company.

Today the DeForest name is to be found on—

- Receiving Tubes
- Transmitting Tubes
- Special Purpose Tubes
- Transmitters
- Carrier-Current Equipment
- Speech Amplifiers
- Centralized Receiving Systems
- Short-Wave Receivers
- Facsimile Apparatus
- Television Equipment from Home to Studio

DeForest does not rest on its laurels. Having contributed the

- Audion or practical radio tube
- Regenerative principle
- Oscillating tube circuit
- Audio amplifier
- Practical radio telephone
- Practical radio telegraph
- Broadcasting of entertainment
- Outstanding features of 1931 tubes

—the very foundations of our present radio industry, the DeForest organization looks ahead rather than behind in serving you.

See our unique DeForest exhibit, during R.M.A. Trade Show, by visiting Booths 92, 93, 96 and 97, facing main entrance, Hotel Stevens. Or if you prefer, write for our Silver Anniversary Souvenir.

DE FOREST
RADIO
CO
PASSAIC
NEW JERSEY

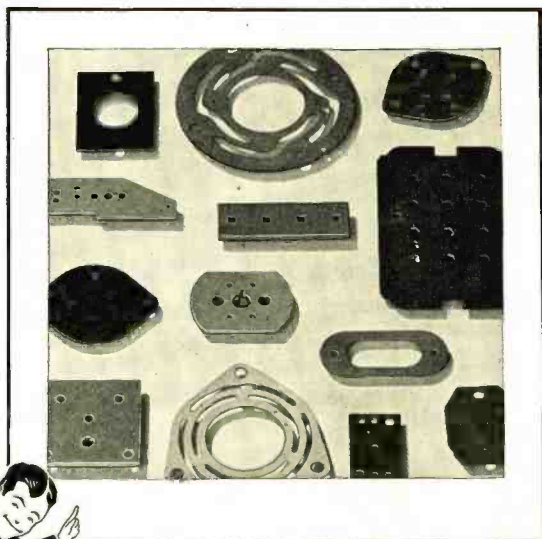

A few representative pieces of Textolite laminated prepared for application to radio receivers

MEET — the
Radio-frequency
Family of

TEXTOLITE LAMINATED

General Fabricating Co.
37 East 18th Street
New York City

Electrical Insulation Corp.
308 W. Washington St.
Chicago, Ill.

JOIN US IN THE GENERAL
ELECTRIC PROGRAM, BROAD-
CAST EVERY SATURDAY EVE-
NING ON A NATION-WIDE
N.B.C. NETWORK

EXHAUSTIVE tests show that in the radio-frequency grade of Textolite laminated the power-factor is so slightly changed by wet or dry conditions that humidity ceases to be a problem. This distinguishing quality, combined with characteristics of easy machinability and mechanical strength, accounts for the use of Textolite in leading radio receivers.

Ask the Textolite specialist at the G-E office in your vicinity, or representatives of the eastern or western fabricators, to outline the properties of this insulating material which make it desirable for application to the set you manufacture.

SHEETS

RODS

TUBES

GENERAL  ELECTRIC

SALES AND ENGINEERING SERVICE IN PRINCIPAL CITIES

831-4

R M A Convention at Chicago

Leaders of radio industry launch
new start

THE convention of the Radio Manufacturers Association, Inc., in session in Chicago, June 8-12, 1931, offers opportunity for every radio set and parts manufacturer to get a new start toward prosperity.

There are signs on all sides that the leaders of other industries have gained all there is to be gotten out of a period of business depression, in the way of readjustment, and are now in position to plan manufacturing and sales campaigns which should lead to a restored, but sound, prosperity.

As the tide turns radio manufacturers will be found ready to go forward in the procession.

The Chicago show will demonstrate this readiness, and will record the desire of every member of the Association to do his part.

The officers for 1931 are: Morris Metcalf, president; B. G. Erskine, vice-president; A. L. Walsh, vice-president; Bond Geddes, executive vice-president; M. F. Flanagan, executive secretary; E. N. Rauland, treasurer.

The directors, including the president and vice-presidents, are: William Sparks, L. E. Noble, L. A. Hammarlund, J. C. Tully, N. P. Bloom, Leslie F. Muter, R. J. Emmert, H. C. Forster, Fred D. Williams, J. Clarke Coit, R. T. Pierson, H. B. Richmond, G. K. Throckmorton, H. S. Hyde, R. W. Jackson, A. C. Kleckner, E. E. Kauer, J. M. Skinner.

Committee chairmen are: Convention arrangements, Leslie F. Muter; Engineering, H. B. Richmond; Advertising, Paul Ellison; Fair Trade Practice, L. E. Noble; Foreign Trade, Arthur Moss; Legislation, C. C. Colby; Show Committee, H. H. Frost; Statistics, G. C. Furness.

Big Radio Show and Crowd Assured

In attendance and exhibits, another successful RMA convention is assured, according to final reports on plans for the annual radio industry gathering which were received by the Board of Directors of the Radio Manufacturers Association at their meeting May 14 at Briarcliff Lodge, New York. More



Bottom, center, Morris Metcalf, President, R.M.A. Bottom, right, Bond Geddes, Executive Vice-President. Bottom, left, M. F. Flanagan, Executive Secretary. Upper, left, H. B. Richmond, Engineering Division. Upper, right, B. G. Erskine, Vice-President.

new radio products, including television, will be exhibited in the trade show at the Stevens Hotel in Chicago than ever before in one year, according to reports to the RMA Board. President Morris Metcalf of Springfield, Mass., presided and received reports from Major H. H. Frost of New York, chairman of the Association's show committee, and Leslie F. Muter of Chicago, chairman of the convention committee.

Of the leading radio manufacturers, 130 will have exhibits in the trade show for which nearly 24,000 square feet of exhibit space already has been assigned, with more applications being received. The large Exhibition Hall and Grand Ball Room of the Stevens Hotel will be required to take care of the many exhibits. A larger proportion of manufacturers of the RMA will have exhibit space than ever before at any RMA trade show for the last three years.

Several thousand reservations of radio jobbers, dealers and others in the industry already have been made at the four official hotels in Chicago, the Stevens, Blackstone, Congress and Auditorium. Four special trains from the East, three from the New York metropolitan territory and one from

New England, already have been sold out. Other special trains are being arranged from the Pacific Coast, Southwest and other points. The trade show attendance will be stimulated by the concurrent convention during the week of June 8 in Chicago of the music industries and the annual "Furniture Mart" of the furniture industries.

Many interesting speakers and entertainment events have been arranged on the convention program. In entertainment the highlight will be the RMA "Stag Party" on Wednesday evening, June 10, and preceding this, on Tuesday evening, there will be the annual banquet.

Many Problems

At this convention the manufacturing and sales executives will have up for consideration many pressing problems which confront the radio industry.

Most of these problems concern merchandising of radio receivers, frozen stocks, credits, servicing, replacements, and volume of production.

The opportunity should be availed of by all interests to plan as cooperatively as is possible in a competitive industry.

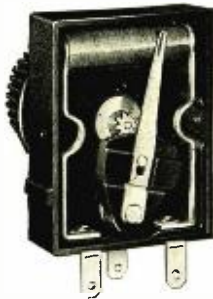

In the Bradleyometer approximately 50 solid resistance disks are interleaved between metal disks forming a resistance column of any desired value. No other resistor offers such flexibility or accuracy.

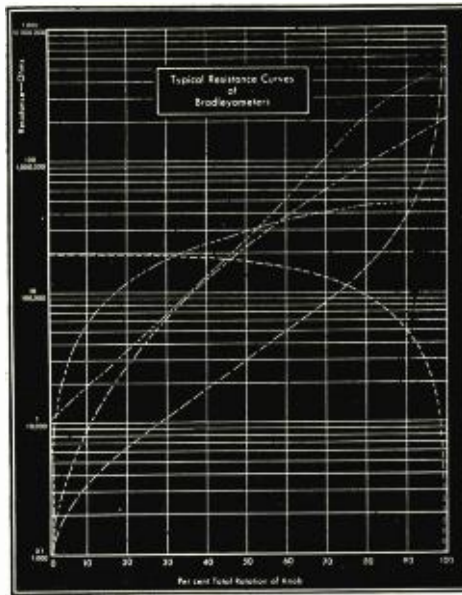

Type A, Single Bradleyometer



Type AA, Double Bradleyometer



Type AAA, Triple Bradleyometer

With Leads



Radio Resistors

Fixed or Variable for any Electronic Circuit

Without Leads



BRADLEYUNIT RESISTORS are made in five sizes, with or without leads. All Bradleyunits are color-coded to meet set manufacturers' specifications. These solid molded resistors are accurately calibrated and have great mechanical strength. They are used by the world's largest radio manufacturers for providing correct C-bias, plate voltage, screen grid voltage and for use as grid leaks.

The Bradleyometer is a stepped potentiometer of most amazing performance. It has astounded radio engineers who were skeptical of its advertised performance. Any type of resistance-rotation curve can be arranged to meet your requirements. Samples will be sent to established manufacturers of electronic apparatus, for test and trial.

Get an Allen-Bradley quotation on your next resistor order.

Allen-Bradley Co.

112 W. Greenfield Ave.

Milwaukee, Wisconsin



ALLEN-BRADLEY RESISTORS
Produced by the makers of Allen-Bradley Control Apparatus

RADIO ENGINEERING

Production, Administration, Engineering, Servicing

JUNE, 1931

The variable-mu tube and distortion in radio receivers

By A. G. CAMPBELL*

Here is an authoritative account of the principles upon which the new variable-mu, or super-control radio tubes operate.

THE recent announcement by several prominent vacuum tube manufacturers of another special purpose amplifier tube calls for a detailed explanation of the characteristics and the uses of this new tube. The fundamental principle of the new tube has been clearly set forth by Ballantine and Snow¹ of Boonton Research Corporation, to whom its development is due. Briefly, the tube is so designed as to have a variable-mu factor instead of the fixed mu factor of the structures used heretofore. By this means the plate-current grid-voltage characteristic is specially shaped so as to reduce the higher-order curvature which is responsible for distortion and cross-talk production. The term "variable-mu" is thus aptly applied to designate the new tube. The variable-mu tubes designed as radio-frequency amplifiers for broadcast receivers have been assigned the type number 551. The type 551 tube has the same characteristics at normal operating voltages ($E_{gc} = -3$, $E_{gs} = 90$, $E_p = 250$) as the widely used type '24. Its construction is somewhat similar to the type '24.

In designing a radio receiver, it is necessary to decide upon a method of

controlling the overall sensitivity, to satisfactorily allow the reception of signals of wide difference in amplitude. A method which is often used consists in changing the individual radio-frequency amplifier stage gain by variation of control-grid or screen-grid voltage. At first glance, this appears to be an excellent method, but experience reveals several serious defects, among which is the introduction of objectionable distortion of the received signal modulation. This distortion effect may vary greatly, from a value so small as to be unnoticeable to a value so great as to render received signals unintelligible.

An ideal amplifier tube would be a one way repeater in which the output voltage would be a linear function of the input voltage. Use of a tube of this type would introduce zero distortion, as the output voltage waveform would be an exact replica of the input voltage waveform.

Amplifier tubes used heretofore have fulfilled the above condition over limited ranges only. However, modern receivers may be called upon to operate with the introduction of a negligible amount of distortion with a variation of input voltage of the order of one million to one. This requirement has been responsible for the design of the variable-mu tube. Reference to Fig. 1

points out the manner in which the type 551 allows the use of input voltages 25 times greater than may be possibly used with the type '24. It will be observed that the static I_p - E_{gc} characteristic for type '24 is reasonably linear from $E_{gc} = 0$ to $E_{gc} = a$. From $E_{gc} = a$ to $E_{gc} = b$, the departure from linearity becomes serious and limits the use of the tube to extremely small input signal voltages. Due to the fact that modern receivers must necessarily be made very sensitive, operation with large input signals requires operation in the region $E_{gc} = a$ to $E_{gc} = b$. Examination of the type 551 characteristic shows that departure from linearity is of account only in the region $E_{gc} = c$ to $E_{gc} = d$. Between $E_{gc} = d$ and the point of cut-off, the relation between I_p and E_{gc} remains nearly linear.

A mathematical analysis of the action of a radio-frequency amplifier gives the best understanding of the problem. The plate impedance of the type 551 tube averages about 0.3 megohm so that we may assume a conventional interstage radio-frequency filter to act as nearly a short circuit. Therefore, mathematical relations derived from the static curves in Fig. 1 may be used directly to calculate voltage gain and distortion of an amplifier stage. If the static control grid bias be the value d , and there be applied a change of bias, e_e , then there will be an excursion of plate

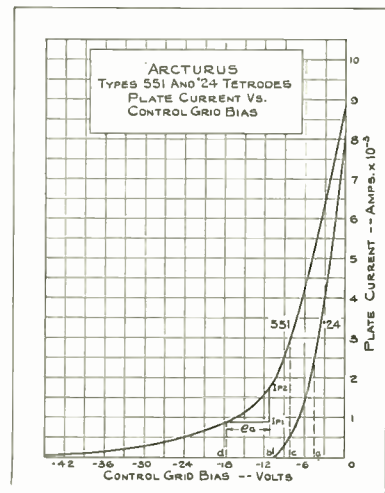

Fig. 1.

* Research Engineer, Arcturus Radio Tube Company.

¹ Stuart Ballantine and H. A. Snow. *Proceedings Inst. Radio Engineers*, December, 1930.

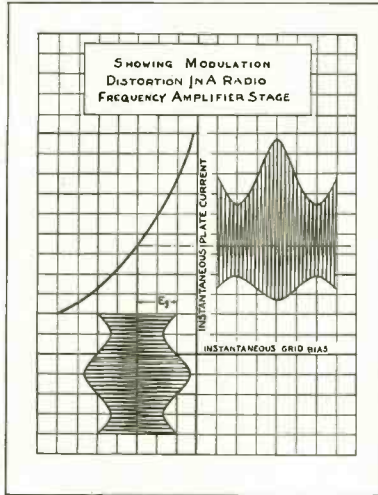

Fig. 2.

current, $i_{p2} - i_{p1}$. Let the quantity $i_{p2} - i_{p1}$ be known as i_p ; and e_g will represent the variation in grid bias while i_p is the corresponding variation in plate current. It is a fact that for limited values of e_g , i_p will be represented by a convergent Maclaurin's series:

$$i_p = \frac{\partial i_p}{\partial e_g} e_g + \frac{1}{2} \frac{\partial^2 i_p}{\partial e_g^2} e_g^2 + \frac{1}{3} \frac{\partial^3 i_p}{\partial e_g^3} e_g^3 + \frac{1}{4} \frac{\partial^4 i_p}{\partial e_g^4} e_g^4 + \frac{1}{5} \frac{\partial^5 i_p}{\partial e_g^5} e_g^5 + \dots \quad (1)$$

The reason for the absence of the first constant term will be apparent if we think of an auxiliary pair of axes originating at the point d , i_{p1} . That is, the constant term is then zero. The values of the successive differential coefficients are those obtained at $e_g = 0$.

Now, if e_g is an oscillation of high frequency of the form $E_g \sin \omega t$, substitution in (1) yields

$$i_p = \frac{\partial i_p}{\partial e_g} E_g \sin \omega t + \frac{1}{2} \frac{\partial^2 i_p}{\partial e_g^2} E_g^2 \sin^2 \omega t + \frac{1}{6} \frac{\partial^3 i_p}{\partial e_g^3} E_g^3 \sin^3 \omega t + \frac{1}{24} \frac{\partial^4 i_p}{\partial e_g^4} E_g^4 \sin^4 \omega t + \frac{1}{120} \frac{\partial^5 i_p}{\partial e_g^5} E_g^5 \sin^5 \omega t + \dots \quad (2)$$

An harmonic analysis of the individual terms of (2) by a Fourier's cosine and sine series development will show that the terms containing the even order derivatives have only direct current and even harmonics of the input frequency; while the terms containing the odd order derivatives have the fundamental and odd harmonics of the input frequency. The interstage filter of the radio-frequency amplifier is responsive to only the terms of fundamental frequency, and collecting these, we have

$$i_p = \left[\frac{\partial i_p}{\partial e_g} E_g + \frac{1}{8} \frac{\partial^3 i_p}{\partial e_g^3} E_g^3 + \frac{1}{192} \frac{\partial^5 i_p}{\partial e_g^5} E_g^5 + \dots \right] \sin \omega t \quad (3)$$

Hence, when the magnitudes of

$\frac{\partial^3 i_p}{\partial e_g^3}$, $\frac{\partial^5 i_p}{\partial e_g^5}$ and other odd order derivatives become comparable to $\frac{\partial i_p}{\partial e_g}$ the

output current will no longer be proportional to the input voltage. This is shown graphically by Fig. 2, from which it is seen that the envelope of the modulated output is not symmetrical with respect to the line of static plate current. The physical meaning of this is that the degree of modulation has been changed, and furthermore that some extraneous modulation frequencies have been introduced.

The following analysis will enable us to find the amount of modulation increase. Assume for simplicity that the fifth and higher order derivatives are negligible. Let the input voltage be given by $E_g (1 + m \sin pt) \sin \omega t$.

From equation (3)

$$i_p = \left[\frac{\partial i_p}{\partial e_g} E_g (1 + m \sin pt) + \frac{\partial^3 i_p}{\partial e_g^3} \frac{E_g^3}{8} (1 + m \sin pt)^3 \right] \sin \omega t$$

Expanding this

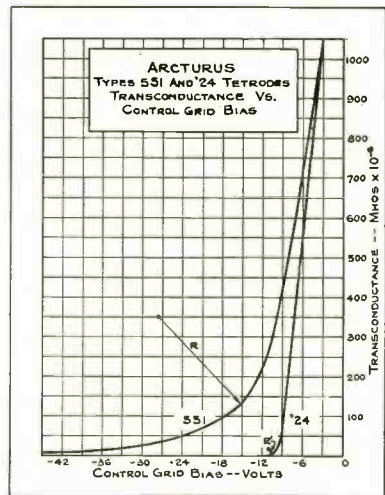

Fig. 3.

$$i_p = \left[\frac{\partial i_p}{\partial e_g} E_g + \frac{\partial i_p}{\partial e_g} m E_g \sin pt + \frac{\partial^3 i_p}{\partial e_g^3} \frac{E_g^3}{8} (1 + 3m \sin pt + 3m^2 \sin^2 pt + m^3 \sin^3 pt) \right] \sin \omega t \quad (4)$$

If m is small the terms containing m^2 and m^3 may be neglected. The new percentage of modulation is then the ratio of the peak value of the audio-frequency variation to the peak value of the unmodulated wave. This will be

$$m' = \frac{\frac{\partial i_p}{\partial e_g} m E_g + \frac{3}{8} \frac{\partial^3 i_p}{\partial e_g^3} m E_g^3}{\frac{\partial i_p}{\partial e_g} E_g + \frac{1}{8} \frac{\partial^3 i_p}{\partial e_g^3} E_g^3}$$

The ratio of the new modulation m' to the original modulation m , is

$$\frac{m'}{m} = \frac{\frac{\partial i_p}{\partial e_g} E_g + \frac{3}{8} \frac{\partial^3 i_p}{\partial e_g^3} E_g^3}{\frac{\partial i_p}{\partial e_g} E_g + \frac{1}{8} \frac{\partial^3 i_p}{\partial e_g^3} E_g^3}$$

The quantity $\frac{\partial i_p}{\partial e_g}$ is the transconductance of the tube, usually called S_m . The ratio $\frac{m'}{m}$ is then nearly equal to

$$1 + \frac{E_g^2}{4 S_m} \frac{\partial^2 S_m}{\partial e_g^2} \quad (5)$$

In order to find the distortion of modulation, rewrite equation (4) as follows:

$$i_p = \left[\frac{\partial i_p}{\partial e_g} E_g + \frac{\partial i_p}{\partial e_g} m E_g \sin pt + \frac{\partial^3 i_p}{\partial e_g^3} \frac{E_g^3}{8} (1 + 3m \sin pt + \frac{3m^2 - 3m^3 \cos 2pt}{2}) \right] \sin \omega t$$

This assumes m small enough so that the term containing m^3 may be neglected. The ratio of the double frequency modulation to the fundamental modulation is

$$\frac{3 \frac{\partial^3 i_p}{\partial e_g^3} m^2 E_g^3}{16 \frac{\partial i_p}{\partial e_g} m E_g + \frac{3}{8} \frac{\partial^3 i_p}{\partial e_g^3} m E_g^3}$$

This is the effective distortion introduced by the amplifier tube under consideration and may be re-written as follows:

$$D = \frac{1}{100} = \frac{1}{2} \frac{m}{1 + \frac{8 S_m}{3 E_g^2} \frac{\partial^2 S_m}{\partial e_g^2}} \quad (6)$$

where D is the percentage distortion and $S_m = \frac{\partial i_p}{\partial e_g}$. Fig. 3 shows

the transconductance-grid bias characteristic for the type 551 and type '24 tubes. The use of these tubes to control sensitivity of a radio receiver depends upon the variation of S_m with change of control grid voltage. If the antenna voltage is impressed directly upon the input of the first tube, it is evident that the reception of strong signals will necessitate the use of the tube at small values of S_m .

Correlating equation (6) and Figure 3, $\frac{\partial^2 S_m}{\partial e_g^2}$ is the rate of change of slope of the $S_m - e_g$ curve. Large values of $\frac{\partial^2 S_m}{\partial e_g^2}$ correspond to small values of radius of curvature, R . Note that for the type '24 tube the radius (Concluded on page 44)

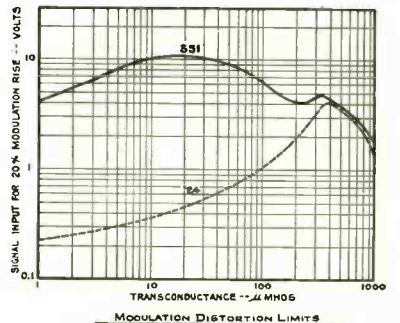

Fig. 4.

A radio receiver for police service

By VIRGIL M. GRAHAM*

This Description of a Police Radio Receiver for Automobile Use Is Interesting in View of the Rapidly Increasing Number of These Installations

THE use of radio by city, county, and state police is increasing very rapidly, and now has ceased to be a curiosity, becoming a necessity in up-to-date police work. Police radio had its beginning in a small way, the receivers being adapted broadcast receivers in some cases. Then came aircraft equipment converted for the purpose and other arrangements. The latest step in advance is the development of receivers designed especially for police service.

The following paragraphs describe such a receiver built with the idea of making a receiving system for police work, which would incorporate a number of years' experience in building broadcast and aircraft receivers with the special electrical and mechanical needs of this particular service.

With this idea in mind, the general specifications were laid out as follows:

A. Electrical Characteristics: (1) Extreme sensitivity; (2) automatic gain control; (3) ample power output; (4) proper reproduction of voice frequencies; (5) low drain on A and B batteries; (6) good selectivity; (7) fixed tuning.

B. Mechanical characteristics: (1) Rugged construction; (2) shock-proof mounting; (3) receiver unit easily removable.

The superheterodyne type of circuit was chosen because of the greater ease in obtaining high sensitivity, and good selectivity at the high frequencies assigned to police service. The signal picked up on the antenna system was taken through two tuning systems to the control grid of the mixer or first detector tube. The output of the oscillator is likewise coupled into this circuit. The signal in the output of this tube, being the intermediate frequency of 175 kilocycles is fed through two stages of i-f. amplification to the demodulator or

second detector. The tube giving the automatic gain control is coupled to the output of the second i-f. amplifier tube. The audio output of the demodulator is fed into the audio tube, and thence to the loudspeaker. Thus, there is a total of seven tubes, five of which are screen-grid tubes, one (the oscillator) a general purpose tube, and one (the output tube) a pentode. All these tubes are of the heater type, and are discussed further in the following paragraphs.

The automatic gain control system (known in broadcast receivers as automatic volume control) regulates the sensitivity of the receiver for the strength of the received signal, thus holding the sound output of the loudspeaker substantially constant over an extremely wide range of input signal. This feature is important as the field strength pattern encountered driving around city streets, and even country roads, varies abruptly and greatly. This control is accomplished by the use of a screen-grid tube whose control grid is coupled to the output of the second i-f. amplifier. This tube acts as a peak voltmeter, and as the signal on the control grid is increased, the plate current increasing builds up an increasing voltage in the

plate circuit resistor. This voltage (negative to ground) is fed back to the control grids of the mixer and two i-f. amplifier tubes. The gain is thereby regulated as stated above, so that the sound output does not vary appreciably from 10 to 100,000 microvolts input. The good selectivity required is obtained as there is a total of five tuning systems in the signal path. The tuning is fixed for the frequency assigned to the particular system, and is adjusted by means of aligning capacitors which are inaccessible when the chassis is in the enclosing case.

Special Tubes

The heater type tubes mentioned have been specially designed for automobile service. The heaters operate directly from the car battery, and their characteristics are such that the "A" current consumption of the receiver is only

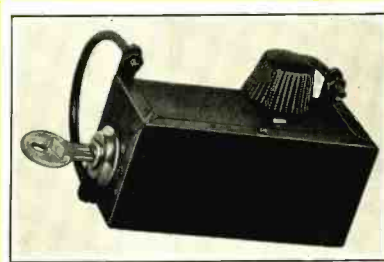

Fig. 2. Control box for mounting on steering column, containing volume control and lock switch.

slightly over two amperes. Three types of these tubes are used, namely, screen-grid, with characteristics similar to the 224; general purpose, with characteristics similar to the 227; and a pentode output tube with a power output somewhat greater than the 171-A.

The car battery is used as the "A" battery and three heavy-duty "automobile" "B" batteries are employed. The "C" battery is specially built for the purpose, and supplies the voltage for the automatic gain control tube as well as regular bias voltages for the mixer tube and output tube.

The proper reproduction of voice fre-

Fig. 1. Bottom view of police receiver chassis, showing wiring.

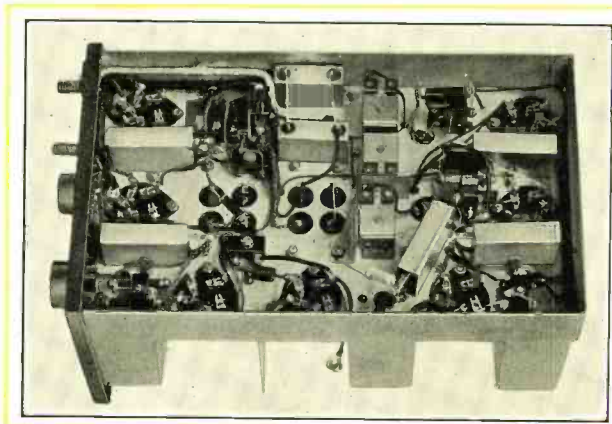

* Radio Engineer, Stromberg-Carlson Telephone Mfg. Company.

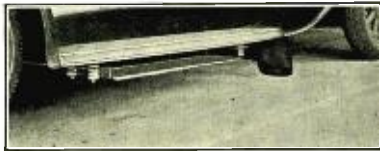

Fig. 3. Antenna plate mounted on running board. Note method of installation. One of these plates is used on each side of the car.

quencies is obtained by careful design of the audio system in conjunction with a loudspeaker built for this service. The volume control varying the sound output from the speaker is connected in the circuit between the output tube and the speaker. This necessitates that the audio system be designed so that the output tube is not overloaded at the detector output level determined by the automatic gain control. This volume control is mounted in a small box with the on-off lock switch. This control box is fastened to the steering column.

Magnetic Speaker

The loudspeaker is of the magnetic cone type, and is housed in a sub-

stantial frame casting. It is mounted in the top of the car just back of the front seat where it is out of the way and gives good sound distribution everywhere in the car.

The rugged mechanical construction was secured by mounting the receiver apparatus on a substantial steel base to which is also fastened a heavy end cover. This chassis assembly then fits into a strong steel box. Shock-proof mounting is obtained by mounting this receiver unit on four "pistons" each completely suspended in sponge rubber. The receiver unit is fastened to these four pistons by suitable clamps.

The receiver unit is made easily removable by arranging all electrical connections to it with the exception of the antenna to be made by means of two plug type connectors. Thus, to remove a receiver unit it is only necessary to disconnect the antenna, remove the two connection plugs, and unclip the unit from the shock-proof mounting. This feature was specified so that in case of tube failure when the receiver is in service another unit can quickly be substituted and the patrol car not detained.

The Antenna

The antenna system consists of two plates which are mounted on insulators beneath the running boards. These two plates are connected together to the antenna post of the receiver unit. The "ground" is made to the frame of the car through the connection of the "A" battery to the frame. Experiments showed that this type of antenna system gave a much more satisfactory signal pickup than the type using screen or wires in the roof of the car, and had the very considerable advantage of reducing ignition noise.

The usual precautions for elimination of ignition interference in automobile radio installations are taken.

The recommended method of mounting the receiver unit, and "B" and "C" batteries is to locate them in a trunk in the rear of the car. This method provides accessibility for servicing as well as protection from damage and unauthorized tampering, and leaves the tonneau of the car free for passenger use.



A Capacity, Inductance and Impedance Conversion Chart

By H. W. ANDERSON

RADIO and communication engineers will find the accompanying chart an aid in computing the reactance of condensers and inductances at various frequencies. It will also show the inductance and capacity required to resonate at various frequencies. Thus it will eliminate a good deal of routine calculation.

If frequency and impedance are plotted as the coordinates on log graph paper constant capacity lines will be at 45 degrees to the coordinates. Constant inductance lines will also be at 45 degrees to the coordinates but 90 degrees to the capacity lines. The frequency range is from 10 to 10,000 c.p.s. and the impedance from 100 to 100,000 ohms.

An inductance and a capacity are said to be in resonance when their impedances are equal. Therefore the intersection of a capacity and an inductance line is the resonant frequency of that combination. For example, to find the capacity necessary to resonate at 4,000 c.p.s. with 85 millihenrys inductance, follow the 4,000 cycle line to where it intersects with the 85 millihenry line. At this point estimate the capacity that would intersect the 85 millihenry line. This would be about .02 microfarad.

The inductance scale runs from 5

millihenrys to 200 henrys and covers practically all the inductances ordinarily used. The capacity scale runs from .005 to 10 microfarads and embraces the sizes commonly available. However it is very simple to add more lines. If the formula for capacitive reactance X_c equals $\frac{1,000,000}{2\pi FC}$ is used at 100 c.p.s. for the capacity required, the

balance of the points necessary to draw the line may be had at 1,000 and 10,000 c.p.s. by merely dividing the answer by 10 for the former and 100 for the latter. More inductive lines may be added in a similar method except that the answer is multiplied by 10 and 100 for 1,000 and 10,000 cycles respectively. The formula for inductive reactance is X_L equals $2\pi FL$.

A useful capacity inductance and impedance chart.

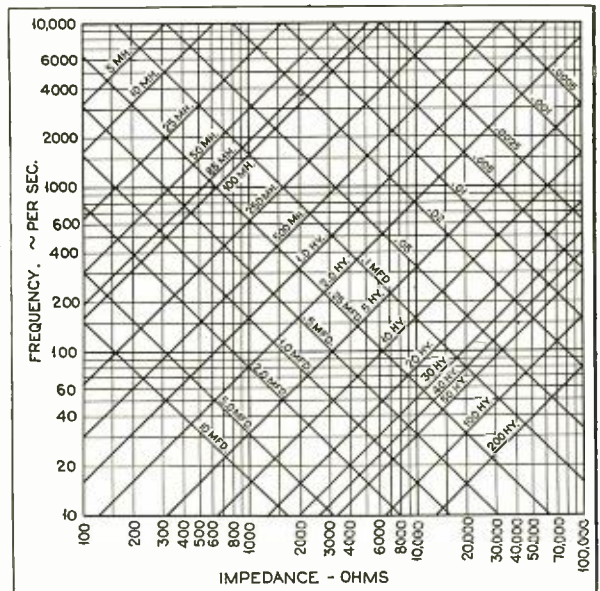

Amplitude modulation versus frequency modulation

By VERNE V. GUNSOLLEY*

In which we are reminded that a component is a component no matter how complex sometimes it may appear.

WHEN is a component not a component? When it is a sideband! That is, if we are to believe all we hear and read regarding the sideband theory and a recent radio receiver development.

One of the simplest conceptions in radio engineering is an alternating current at resonance, modulated in volume. The function of the latest 400 kw. transmitter is to radiate with 400 kw. of radio frequency energy, or, simple alternating current at resonance. Attached to this huge radio-frequency, or alternating-current generator is a huge volume control which varies the output of the generator from zero to 1600 kw in the case of 100 per cent modulation, and so rapidly that the frequency of variation becomes audible when suitably detected. This immense volume control is otherwise known as a modulator stage. It is controlled in turn through intermediate stages of amplification by a simple microphone on which audible frequencies have been impressed either by the voice or musical, or non-musical instruments. Now, all the while this has been going on a quartz slab about the size of a quarter has been holding the radio-frequency rigorously constant, so that we may safely conclude that the output on the antenna is a single radio-frequency that is varied in volume between the limits of zero and 1600 kw.

This principle constitutes the first commercially practicable principle of transmission of audio modulation over a radio wave. Due to recent developments of an equally old principle we are now confronted with the study of another means of modulation.

Suppose we hold the output of the

transmitter at constant amplitude, and instead of varying the volume control by means of the microphone, place the microphone in the crystal circuit instead in such manner as to vary the radio-frequency a few cycles either way from the assigned frequency. We will then have constant current modulated in frequency.

In this kind of modulation as in the case of amplitude modulation there is no definite law of variation of the modulation, but for purposes of analysis we may conveniently assume that the modulation is sinusoidal; that is, that the frequency varies with time at a sinusoidal rate.

In the case of amplitude modulation, the mathematical expression for the carrier wave is

$$e = E \sin \omega t \dots \dots \dots (1)$$

where E is the amplitude or voltmeter reading; ω is $2\pi f$, where f is the carrier frequency, and t is the time in seconds. From this it is plain that e is the instantaneous value of the carrier wave, while E is the amplitude of the carrier wave.

Under modulation we vary the amplitude E at such a rate that the voltmeter, being a practical instrument, cannot longer keep up with it, but at very slow rates of modulation we see that the voltmeter reading pulsates to follow the amplitude variations; from which we conclude that a modulated alternating e.m.f. is a pulsating alternating e.m.f. One conception that must be understood here is that while the instantaneous value of e may be any value, even zero, and in fact does change through all values between plus and minus and the limits of the peak of the wave every cycle, yet, the amplitude E remains constant and invariable all the time as proven by the fact that the voltmeter

maintains a steady indication all the while the instantaneous value of the e.m.f. is rapidly varying. If we lower E, the voltmeter indication will likewise fall.

We can vary E by means of an amplitude control, which is a volume control, or, as more commonly known, a modulator. Let us vary E sinusoidally at an audio frequency f' . This is the modulation frequency. Suppose we vary it up and down by a fraction of itself equal to k called the modulation factor, then the amplitude of the modulation, that is, the amplitude of the pulsations in the carrier is kE, and, the amplitude of the carrier (not its instantaneous value) is at any instant given by the expression

$$(E + kE \sin \omega' t) \dots \dots \dots (2)$$

where ω' equals $2\pi f'$.

This is merely the value of the voltmeter reading as it pulsates back and forth over the scale (under modulation rates so slow as to permit it to follow the voltage variation). Whereas in

(1) the amplitude remained constant it is now varying sinusoidally, all the time the alternating e.m.f. is varying sinusoidally, but at audio-frequency not radio-frequency. The complete expression for the modulated carrier is obtained by substituting the varying amplitude for the steady state amplitude E, that is, by substituting (2) in the place of E in (1). This gives

$$e' = (E + kE \sin \omega' t) \sin \omega t \dots \dots (3)$$

Or, expanding;

$$e' = E \sin \omega t + kE \sin \omega' t \sin \omega t \dots (4)$$

The right-hand member in the right-hand term may be removed and replaced by two terms each equal to half value. This is as simple as removing an apple from a dish and replacing it by two halves of an apple. While the apple is now of different form, the number of apples present is still the same and the equation is not altered except in form. This gives

$$e' = E \sin \omega t + \frac{1}{2} kE \sin \omega' t \sin \omega t + \frac{1}{2} kE \sin \omega' t \sin \omega t \dots \dots (5)$$

The value of (5) is still the same as that of (4).

Now if we add a certain amount to the middle term, and take away the same amount from the last term, the equation will still have the same value and will be unchanged again except in form. Let this amount be $\frac{1}{2} kE \sin \omega t \sin \omega' t$. The equation then becomes

$$e' = E \sin \omega t + \frac{1}{2} kE \sin (\omega + \omega') t + \frac{1}{2} kE \sin (\omega - \omega') t \dots \dots (6)$$

Thus (6) is of different form but is still equal to (3).

Inspection of (3) shows it to be an alternating e.m.f. of constant frequency but of variable amplitude, while inspection of (6) shows it to have three different frequencies all of unvarying amplitude; that is, unmodulated.

Now if we take the three frequencies expressed in (6) and add them we do

* Research engineer, National Battery Broadcasting Co., Station KSTP.

not get a constant amplitude modulated in frequency, but instead we get (3) which is a constant frequency modulated in amplitude. Such being the case it is utter folly to try to analyse the frequency modulated carrier on the basis of sidebands and carrier shown in (6). There is no way they can be added up into a frequency-modulated constant-amplitude result. There is positively no sense in arguing the subject with those of understanding such as to be unable to see the radical difference between the two systems of modulation, or who fail to realize that the components of one particular type of phenomena cannot be resolved into some other entirely different resultant. The resultant of (6) can never be anything but (3), and (3) is surely anything but the expression for frequency modulation. This may be more apparent when we examine the expression for frequency modulation.

When the frequency is modulated sinusoidally, it may be represented graphically by a sinusoidal wave. Let the mean value of frequency f be the zero line of the modulation frequency f' . This is the frequency at no modulation. Let the positive peak of the modulation cycle represent the upper limit of frequency variation, f_u . The negative peak of the modulation cycle is then the lower limit of the frequency variation, f_l . The amplitude of the modulation is then either $(f_u - f)$, or $(f - f_l)$. Both are the same, in the same way that the positive amplitude is the same as the negative amplitude in an ordinary sinusoidal wave.

If we let ω be the instantaneous value of the frequency of the carrier wave and we modulate the carrier frequency at a rate $\sin \omega't$, through a frequency range of $(f_u - f)$ which is the amplitude of the modulation frequency in terms of carrier frequency, then the expression for the instantaneous value of the frequency is

$$f_0 = f + (f_u - f) \sin \omega't \dots \dots \dots (7)$$

Since the amplitude of the e.m.f. is constant, the expression for the instantaneous value of the frequency modulated e.m.f. is then

$$e'' = E \sin 2\pi f_0 t = E \sin \omega_s t \dots \dots (8)$$

where ω_s is the instantaneous value of the angular velocity due to the varying frequency f_0 . When such an e.m.f. is impressed on a circuit the fundamental frequency of which is f , then the current is alternately lagging and leading; the power factor is therefore likewise alternately lagging and leading, as the impressed frequency passes above and below the natural frequency of the circuit. It is apparent therefore that the unmodulated frequency should not be spotted directly on the peak of the resonance curve of the circuit, but should be located on the straightest possible portion of the side of the selec-

tivity curve so that the limits of frequency modulation are joined by as straight a portion of the curve as possible. In this way, a sinusoidal variation in frequency will give a sinusoidal variation in output or response in the circuit and result in a minimum of distortion. It is believed that this principle has not been observed in the application of the "radiostat," particularly, and that this is partly the cause of the distortion therein.

Output of Crystal Circuit

The output of the crystal circuit is modulated both in frequency and amplitude so that the detector has impressed on it a current that wobbles slightly in frequency, but inappreciably and thus perhaps no more than in ordinary reception by the ordinary superheterodyne, but the variation in amplitude is very great, as in ordinary reception. That is, frequency modulation is traded for amplitude modulation just ahead of the detector. At this point, we

ANACONDA WIRE & CABLE COMPANY'S BUSINESS INCREASES

The fact that the Anaconda Wire & Cable Company, a subsidiary of the Anaconda Copper Company, reported a net profit of \$161,465 or 38 cents a share on the capital stock for the March quarter contrasted with only \$59,417 or 14 cents a share a year ago, throws an interesting side light on the copper wire and cable industry. The increase in profits this year, it is understood, was due to the better diversification of business in the more profitable lines of production, which include the finer wires such as are used in manufacture of radios and automobiles.

may disregard the frequency modulation and consider only the amplitude modulation since the former is so slight and the latter so great. The circuit upon which the amplitude modulation is impressed will behave as for constant frequency, with negligible error, and if very selective, sideband suppression will result. Even if this circuit has no selectivity, but has reactance only as in the case of a d-c. circuit on which a pulsating current is impressed, suppression will take place in the higher audio frequencies. Moreover, if the detector is discriminating, high frequencies will be further depressed from this cause. The sideband theory can apply only to amplitude modulation, and therefore can become active only after frequency modulation has been changed into amplitude modulation. Now if it can be proved that the selectivity of the crystal is an inverse function of its

decrement, the same as in any resonant circuit, then its output will be affected by its own inherent lag in its rise and fall of resonance, and this is equivalent to the suppression of sidebands. However since it is not known whether the response of the crystal is greater than the amplitude of the exciting force, but only greatest at resonance, and, since it must be realized that the addition of resistance does not broaden the selectivity curve but only lowers its altitude (within quite wide and reasonable limits) it is just possible that the selectivity of the crystal can be very high and yet the decrement remain fairly large so that very little suppression of sidebands could result from the tendency of the crystal to remain in oscillation after once excited. This might be determined from experimental research directed towards the finding of the time constant of the crystal, which is the measure of its tendency to persist in oscillation. The actual results of demonstrations as reported in the various journals would indicate that the crystal has a very appreciable time constant, unless the distortion is due to the failure to operate on the straightest possible portion of the selectivity curve as before mentioned.

Application of Sideband Theory

The conclusion is, therefore, that in the radio-frequency amplifier of the frequency modulated receiver, the sideband theory cannot apply; but the moment frequency modulation is converted into amplitude modulation, then, and then only, can and will sideband suppression result in any circuit containing an appreciable time constant; be it due either to the electrical properties of the circuit or the piezo-electrical properties of the crystal. In those portions of the receiver where the frequency modulation principles apply there can be no suppression of sidebands but in those portions containing amplitude variation sidebands will be suppressed, mathematically. Physically, the suppression is due to the lag in the rise and fall of resonance due to the inertia of the circuit to changes in its degree of oscillation. Analytically either viewpoint is correct. The important point is that the Stenode is very clearly governed by the same laws of amplitude modulation as other receivers, but offers the advantage of the super selectivity made possible by the use of a crystal. Moreover the principle of transmission is sound, for, since the sidebands in (6) cannot be resolved into (8) but only into (3), there can be no interference between bands no matter how great the modulation frequency. This is based on the assumption that (8) can never at some future date be proven to be made up of components that have frequencies

falling outside the range of frequency modulation. If found, such components cannot be sidebands as in (6), but will be of some other form, or a Fourier's series. They must be such that when resolved into a resultant they will give (8) and not (3).

Station Separation

It is possible, therefore, to locate stations much closer together by reason of the much narrower frequency bands permissible, and then compensate for the high suppression caused by the great selectivity of the receiver. Such a system cannot cause interference on the sidebands, for, the sidebands are generated (mathematically) at the receiver instead of at the sending station. On the way between sender and receiver the phenomena is expressible by (8). After passing the crystal the phenomena is expressible by either (3) or (6). Thus sidebands are not generated until the energy reaches the crystal.

Analogically it amounts to longitudinal vibration along a string as compared to transverse vibration along a string. If sender and receiver are so connected, then longitudinal vibration will require a band no wider than the dimensions of the string itself. But if energy is transferred along the string by means of transverse vibrations, then stations side by side must be located with greater separation to allow the strings to vibrate freely without interference. With the case of longitudinal vibration the strings could be crowded so close together as to actually be in light contact throughout their length without interfering, but this could never be realized in the case of transverse vibration. If after arriving, the longitudinal vibrations are converted into transverse vibrations, all the room desired is obtainable at the various receivers and this in no way interferes with the transmission of energy along the strings or causes them to interfere with one another.

Unfortunately for the longitudinal system as in the case of the Radiostat, detection requires conversion into transverse vibration, analogically, and this can be obtained from longitudinal vibration only by the use of a converter of excessively great selectivity. The output of such a converter must suffer the results of suppression since it is an amplitude modulated output. However if a detector can be invented now that will function on frequency modulation instead of amplitude modulation, so that selectivity cannot hinder its input, fully as good audio quality as from amplitude modulation will be readily obtainable without resorting to the use of compensated audio systems; and, the sys-

tem throughout will be entirely independent of sidebands.

Therefore we may conclude that the fact the sideband theory is operative in the Stenode the moment frequency modulation is converted into amplitude modulation, makes the audio quality still dependent on the sideband theory; but since this modulation occurs in the receiver instead of at the sender, the resulting sidebands cannot be in the ether between sender and receiver. Since the sidebands are thus confined within the receiver, there is no way they can overcrowd the ether, or prevent sending stations using the frequency modulation principle from being located as close to each other in frequency as the range of frequency modulation adopted as standard will permit.

Required, a Detector to Operate on Frequency Modulation

It is quite probable that transmission and reception on the frequency modulation principle from beginning to end will become a reality. It awaits only a detector that will operate on frequency modulation instead of amplitude modulation. In such event, the sideband

theory will apply at no point along the transmission. Thus far it has been developed in the Stenode to the point where the sideband theory does not apply between sender and receiver and thus can cause no station interference, but it does apply just at the point of conversion and thus causes audio suppression in the higher frequencies in accordance with the sideband theory.

Nothing could be clearer than the proposition that frequency modulation and amplitude modulation are radically different and entirely unrelated phenomena, and that therefore the components of amplitude modulation as in (6) cannot be used to analyze frequency modulation phenomena as expressed in (8). The Stenode demonstrates the truth of the foregoing propositions. It does receive without interference, and yet it does suppress the high frequencies. If it were not true that reception on the Stenode is independent of sidebands up to the crystal, then the compensation in the audio amplifier would also compensate the interference, and in the same manner as it restores the suppressed frequencies it would also restore the interference. This it does not do, thereby demonstrating the truth of the analyses made in this article.



New broadcasting station KDKA near Pittsburgh, Penna.

Installation of radio receivers in the home

By M. ASCH

Shielded antenna lead-ins when used prevent much of the disturbing noises complained of

ONE of the main problems facing the serviceman today is that after installing a new radio receiver in the modern home the noise level input into the set from the antenna should be low enough to enable the user to operate his receiver on the upper as well as on the lower end of the dial.

Until the present time a typical explanation on the part of the serviceman has been: "I'm sorry, madam, but the station you desire to bring in is only a small one and nobody ever listens to it anyway." Or, "Your ice-box or oil-burner, or some other cause of disturbance is responsible for the lack of reception."

This is not true any more. Those stations on the higher frequency end of the dial, broadcasting with a power of 250 watts or more are of a potential service to their communities up to a 50 mile area.

Receivers of 1930-31 are easily able to separate these stations so that if the noise level is reduced to below the voltage input we would be able to receive them with almost the same quality as that of the upper wavelengths depending, of course, on the broadcasting efficiency.

It is curious to note that although commercial broadcast receivers have undergone radical changes since their advent about ten years ago, the installation of the receiver itself remains as heretofore. The same type of lead-in, ground connections, and antenna. Also the same tacking around the room.

Shielding

In recent years shielding has been employed in receivers. At no point within the receiver itself is any radio-

frequency current permitted to wander and cause disturbance or unbalancing to any other circuit. But, how seldom is the real cause of noise disturbance, and other so-called man-made static eliminated before it gets into the radio set through the antenna connection? When the set is tested in the factory it is balanced and adjusted under exact conditions, through an oscillator system or other electrical or mechanical means of broadcasting. The receiver is then neutralized or balanced to each peak point at its maximum and sent forth into the field. But how exceptional is the case where the same receiver works as satisfactorily under the conditions existing in a customer's home? It is true that those stations with enough input come clear, but how about the low-input stations within their serviceable area?

It is also curious to note that the radio manufacturer, once the set leaves his warehouse seldom takes the trouble to see that his merchandise is installed in as painstaking a manner as the receiver has been manufactured. The installer, usually the lowest paid individual of a radio concern, too often does not take sufficient time to do a good job. Usually a service manager tells a serviceman to install the sets with an antenna at right angles to, or facing north and south. Another service manager tells his men to install the antenna at a left angle, or facing east and west. Ask either, why this or that method—the answer may be—"Well, from my experience this is the better way." In other words, a thorough engineering analysis of the antenna and ground requirements in the home is seldom made. If the set seems to play well enough, then the order is—"Leave well

enough alone"—if, on the other hand, the receiver does not perform well, then any stock excuse is advanced.

Shielding, which plays a big part in modern radio sets, is rarely employed by the layman. In an ordinary apartment house installation about 20 feet of braided or shielded lead-in would eliminate very much of the extraneous noise, including the much dreaded elevator clicks. In installing shielded lead-in one has to be very careful that the outside shield is grounded in more than one place; best, at both the incoming window and directly at the ground of the set. Usually the best results obtained are those using the shield as the ground to the set and grounding the outside end near the window.

A certain radio manufacturer was modern enough to equip every d-c. set of a certain model with 50 feet of shielded lead-in. Where this antenna equipment was actually used in installing the receivers, little or no trouble from interference was experienced.

It stands to reason that a modern radio set, which is built with all the engineering knowledge available, should be installed in a workmanlike manner. An educational campaign for public, retailer, service manager and serviceman might well be established through the RMA, that all may be advised of the latest methods approved by engineers to give more freedom from static and other unnecessary noises. For instance, by a filter system so calculated as to efficiently couple the antenna to the set and thus by-pass unnecessary high-frequency currents.

If the public is satisfied that the results obtained are beneficial it will pay the additional charges involved for both time and equipment.

POWERFUL RADIOTELEGRAPH STATION UNDER CONSTRUCTION IN FRANCE

A wireless station more powerful than any that has hitherto been built in France is now under construction just outside of St. Nazaire (Lower Brittany). Destined for telegraph communication between France and shipping in the Atlantic, the new station is expected to be completed by the autumn, according to "Reuter" (Paris).

21 CHINESE RADIO STATIONS TO OPERATE INTERNATIONAL SERVICE THROUGH SHANGHAI

By order of the Ministry of Communications, 21 Government radio stations in China from Tientsin in the North to Ichang in the West and Canton in the South will operate international services after May 15, transmitting through Shanghai.

The design and construction of standard signal generators[†]

By C. J. FRANKS and MALCOLM FERRIS

With modern high grade radio receivers it is important that the systems employed in testing be properly designed.

THE first section of this paper will discuss in some detail the general requirements of any standard signal generator which is to be suitable for the laboratory testing of modern highly sensitive and selective radio receivers. Following this will be descriptions of three particular generator models, each of which was designed to fulfill the general requirements and some special requirements. This section will also consider briefly some of the problems encountered in the performance testing of a signal generator after its construction has been completed.

In the past few years the radio art has developed certain so-called standard tests to be used in rating radio receiving apparatus. These standard tests, in contrast to the old, uncertain method of determining performance by listening tests, provide a simple, fairly accurate, and readily reproducible method of evaluating any receiver in terms of certain quantities such as sensitivity, selectivity, fidelity, overload, etc. These quantities when properly determined define quite accurately the performance of any receiver and so permit the comparative worths of various receivers to be stated. It is the purpose of this paper to describe in detail the apparatus which is necessary for, and the development of which has made possible the making of, these standard tests.

It must be noted in passing that these standard tests, important and significant

though they may be, can never wholly replace listening tests. There are still certain features of receiver performance that cannot fully be determined by the standard tests, and which can best be determined under actual operating conditions. Another important function of the listening tests is to confirm the conclusions reached in the laboratory measurements; this function must always be utilized if the laboratory data are to serve their greatest usefulness.

The apparatus to be described was designed to make possible the rapid and accurate performance of tests on such receivers as come to the engineer for rating, as well as to provide for the laboratory tests which accompany the design of all new receiver models. It is evident that one of the important

uses of such a device is the rapid and continuous testing of a receiver model which is in process of design. A simple method of measurement makes possible the evaluation of each small change or improvement in the receiver design as soon as it is made, so that the worth and economy of each change and its effect on the final performance of the receiver may quickly be determined and its inclusion or exclusion in the final design decided.

The principal requirements of the apparatus for making possible the various tests mentioned above have already been stated in an article by P. O. Farnham and A. W. Barber which appeared in the I.R.E. Proceedings for August 1930.

Reduced to essentials, the apparatus for making tests on a radio receiver consists first of a generator for producing a signal to be introduced into the receiver, and second, some sort of output meter for measuring the audio frequency output of the receiver. Other auxiliary apparatus is of course desirable and necessary for the investigation of certain secondary properties of the receiver, but the standard signal generator and output meter are the chief tools with which the engineer has to deal and, in fact, are the only items necessary for the making of the most important tests, sensitivity, selectivity, fidelity, and overload. Suitable output meters have been described and are available on the market, and need no further exposition here. This brings us to the discussion of the standard signal generator proper, or microvolter, as it is more commonly called.

The Properties and Requirements of a Standard Signal Generator

Simply stated, a standard signal generator is a source of modulated radio frequency voltage whose carrier frequency, modulation frequency, depth of modulation and absolute value of output voltage are all accurately controllable and known. These fundamental properties of the microvolter will bear considerable detailed discussion, but before

Fig. 1. Signal generator for 150 to 7500 Kc. range.

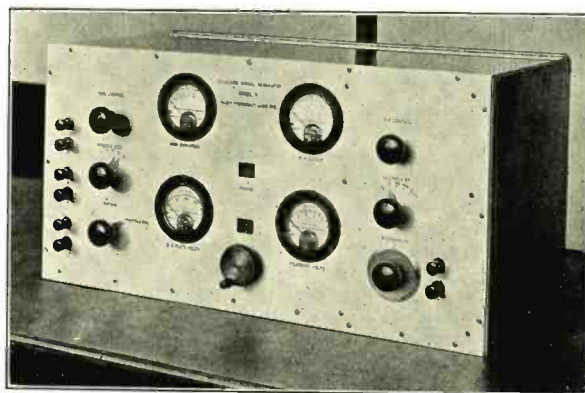

[†] Delivered before the Radio Club of America March 11, 1931.

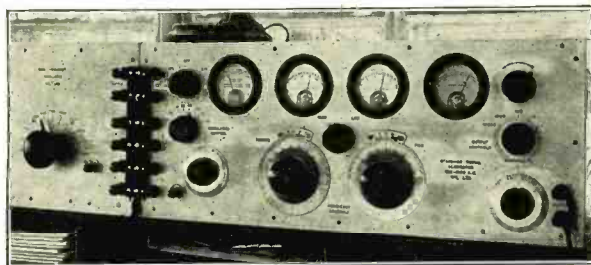

Fig. 2. Signal generator for 150 to 1500 kc. range.

entering into this discussion it may be well to digress long enough to state several other considerations to be taken into account in the design of a practical instrument. They are chiefly concerned with convenience of operation and range of usefulness of the apparatus. While the features to be mentioned are very desirable, they are not to be taken as absolutely necessary to the fulfillment of the fundamental requirements just stated.

1. The complete apparatus should be of such size and weight as to be completely portable, and the power supply requirements should be such as to permit operation from ordinary battery sources. This will permit motorization if desired for field strength investigations.

2. The shielding of the generator should be sufficiently complete to permit its operation in the same room with, and even very close to any receiver apparatus under test.

3. It should be possible to cover the complete range of the generator as regards frequency, output voltage and modulation without the necessity of making any laborious adjustments or changes which might require disassembly of the apparatus.

4. The instrument should be entirely direct reading, so that measurements can be made directly without the use of any calibrations, calculations, or corrections.

5. The instrument must be entirely self-contained, no external meters, attenuators, or other apparatus being permitted.

Fundamental Requirements of Standard Signal Generator

The carrier frequency must be adjustable and known to an accuracy of about one-half per cent over the range of radio frequencies likely to be encountered in present-day receiver design. With the advent of the superheterodyne this range has been considerably extended, until now it includes frequencies from 1,850 kilocycles down to 150 kilocycles or even lower in some cases. In addition to the main frequency adjustment, a fine adjust-

ment for varying the frequency in small steps to at least 30 kilocycles each side of any test frequency must be provided for the making of selectivity measurements. It should be possible to adjust the frequency in increments of about one kilocycle at the highest carrier frequency in the range. The means provided for making this adjustment will ordinarily permit even smaller increments to be read at any lower frequency, due to the characteristics of any practical means for accomplishing this end.

Any consideration of carrier frequency requirements must also include the matter of frequency modulation. This last has of late become of such great importance, due to the increasing amounts of selectivity being built into modern receivers, as to merit discussion in some detail.

The ideal way of obtaining the modulated radio-frequency wave in a microvoltage, without doubt, the modulation of a separately excited amplifier system. With proper design such a system results in an absolute stability of carrier frequency (zero frequency modulation). However, any attempt to design a standard signal generator along these lines very quickly leads to a result which in size and power requirements bears more resemblance to a broadcast transmitter than to a piece of laboratory apparatus. It is not necessary to go into detail on the difficulties encountered in shielding so large a project successfully. For these reasons it is usual to obtain the modulated wave directly from a self-excited oscillator, whose power is purposely kept as small as possible in order to minimize power supply and shielding difficulties. Modulation is readily accomplished by inserting into the plate circuit of this oscillator a voltage containing both direct and alternating components, the ratio between these components being adjusted to give the desired modulation ratio.

In a triode oscillator of the usual type a variation of plate voltage changes the frequency of oscillation. When the plate voltage is varied at an audio-frequency rate the result is an output wave whose amplitude and frequency both are varying over a certain range. When a wave of this type is applied to

a receiver tuned exactly to the generator mean frequency, as is the case when measuring most of the receiver characteristics, no bad effects from the frequency modulation are evident. If, however, the resonant frequency of the receiver differs from the frequency of the impressed signal, as is the case when measuring selectivity, the variation of carrier frequency, in effect, slides the point of coincidence between the wave and the response curve up and down on the curve. This causes a variation of amplitude of the wave reaching the demodulator of the receiver, or in other words the frequency modulation is translated to amplitude modulation.

When operating on one side of the resonance point the amplitude modulation due to frequency modulation adds to the normal amplitude modulation, while on the other side of resonance it subtracts. It is chiefly this effect which causes the large asymmetries noted on a great many of the selectivity curves which have appeared in various radio

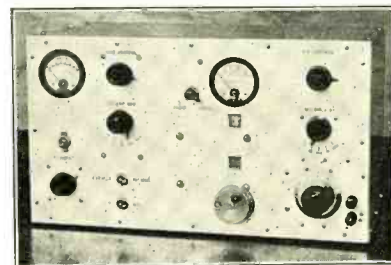

Fig. 3. Miniature portable signal generator.

publications as representing performance data of sample receivers. The amount of amplitude modulation produced from a given amount of frequency modulation is proportional to the slope of the resonance curve at the point of operation. In the modern highly selective receiver it is easily possible, with the amount of frequency modulation usually encountered in a small signal generator, to produce enough amplitude modulation to cancel completely the normal amplitude modulation. The resulting wave has practically zero modulation, except for the fortuitous presence of sundry harmonics, and under these conditions the demodulator may reach radio-frequency overload long before standard output power is obtained from the audio system of the receiver.

The ultimate effect is a selectivity curve which is slightly bulged out on one side of resonance and considerably sucked in on the other; this is usually interpreted as a fault of the receiver under test instead of being charged to the signal generator used.

Frequency modulation in the micro-

volter can always be detected by taking a selectivity curve of a receiver, using constant carrier (or intermediate frequency) voltage at the demodulator as standard signal, rather than audio output. If under these conditions a normal symmetrical curve which does not agree with previous measurements is obtained, and if, during the run in which the demodulator carrier voltage is held constant the audio-frequency output varies through wide limits, the presence of frequency modulation is clearly indicated.

Experience has shown that, in order not to give trouble when used with the highly selective modern receivers, frequency modulation in the microvolter must be held below about 200 cycles for a plate voltage change corresponding to 30 per cent modulation.

The modulation frequency of the standard signal must be readily variable over the entire audio-frequency range comprising the frequencies used in voice and music transmission. Since radio receivers seldom transmit frequencies outside of the range 40 to 7,000 cycles, these frequencies are used as the limits between which the microvolter must be easily modulated. The change of depth of modulation with change of modulation frequency (fidelity of the microvolter) should not vary more than about two per cent over the audio range, if the use of troublesome correction data is to be avoided.

The final fundamental requirement of the microvolter is that the absolute value of carrier voltage appearing at the output terminals shall be accurately adjustable and known. It is safe to say that this one requirement will cause the designer more trouble than all of the others combined, particularly if he tries to live up very strictly to an initial high standard of performance. The reasons for this are many, among them being the complete absence of any absolute method of measurement for radio-frequency potentials of the order of a few microvolts, the unreliability of all practical checking methods, and the relatively tremendous errors caused by stray voltages introduced by invisible couplings and leakages. Thus the requirement stated concerns not only the measurement and attenuation of small voltages but the whole physical structure of the complete apparatus, since the elaborate shielding required to prevent the radiation of stray fields becomes one of the major mechanical problems.

Experience has shown that satisfactory limits of performance as to output are about as follows:

1. The output voltage should be adjustable between one and 200,000 microvolts.

2. Voltages should be indicated with as much accuracy as their known absolute accuracy justifies.

3. The output voltage should be continuously adjustable between the limits stated.

4. The output impedance of the generator should not exceed two ohms.

5. The attenuation system used must give consistent operation over the range of carrier frequencies to be used.

6. Adjustment of the magnitude of the output voltage must have absolutely no effect upon the carrier frequency.

7. The voltage supplied to the attenuation system should be fairly constant with carrier frequency.

8. The voltage appearing at the output terminals when the attenuator is set for zero output should not exceed about one-tenth of a microvolt.

9. The shielding of the complete generator and the wiring of the attenuator must be so carefully worked out that stray radio-frequency potentials greater than about one microvolt cannot be detected anywhere about the apparatus.

It is evident that some of the above points concern not only the attenuator system and structure, but the entire electrical system and mechanical layout of the complete generator.

The Shielding Problem

Some idea of the magnitude of the shielding problem may be obtained from a consideration of the voltage levels to be found in the various parts of a complete standard signal generator system. In a practical system, the one which will be described in detail, the oscillating circuit develops about one hundred volts, while the input to the attenuator proper is one-half volt. Thus if we desire to use outputs of the order of one microvolt, the attenuator must have a useful range of 500,000 to one, while in order to keep strays well below the magnitude of the voltages being used, the shielding system of the micro-

volter is called upon to effect an attenuation in excess of 100,000,000 to one, or a matter of some 160 decibels.

This concludes the detailed consideration of the things which we shall want to find in the signal generator which we are going to build for use in the laboratory. Let us now take up the discussion of the way in which all of these widely varying factors affect the practical design of such a piece of apparatus. One encounters many difficulties in the attempt to consolidate so many requirements into a single physical unity, and many compromises must be made between the various factors. It is safe to say that it is electrically impossible to fulfill in the strictest sense all of the requirements just stated. We must sacrifice some of them almost entirely and fulfill others only as completely as may be done without jeopardizing still others of greater importance than the first. Here is an example of the way it works out:

The shielding problem may of course be considerably simplified if some of the requirements stated in the beginning as being desirable but not absolutely necessary are made less severe. That is, if the generator be operated in a screened room different from the one in which the receiver under test is being operated, the shielding of the generator itself need not be nearly as complete as when the two are to be operated in direct proximity. The simplification is, however, only apparent. It is obvious that the total attenuation between generator oscillator and receiver input must remain exactly as great as ever, so that the total shielding required is not diminished in the slightest. If some shielding is removed from the generator proper it must be put back in another guise, as for example the separate screened room. It is felt that the net

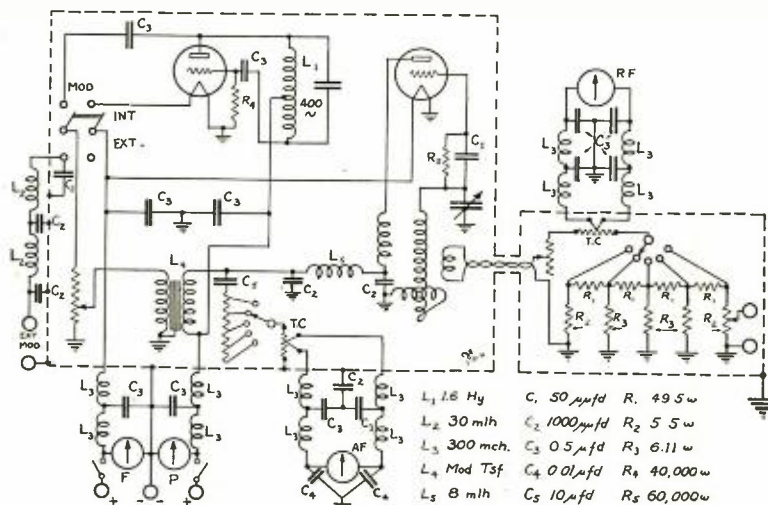

Fig. 4. Generalized circuit of laboratory type generator.

result is an economy when the generator is properly and completely shielded in itself, for the slight additional difficulty of complete shielding is more than compensated for by the elimination of the extra screened room and the extra operator. Most important, however, is the greatly increased facility and convenience of operation and the lessened opportunities for errors of misunderstanding when all of the apparatus involved can be placed within the reach and under the direct control of the engineer making the tests. In all of the generators described in this paper sufficient shielding has been included to make possible operation of the generator very close to the receiver under test.

Practical Examples of Standard Signal Generator Design

Three types of signal generator are shown in the illustrations. The first two, shown in Figs. 1 and 2, are similar in design and construction, both being intended for general laboratory use where performance and convenience of operation are of greater importance than size and portability. The third generator, shown in Fig. 3, is of a much smaller size. It is completely self-contained including batteries, and of course has had certain performance features sacrificed to some extent in order to permit the reduction in size.

The two larger generators differ only in the carrier frequency range covered, and in the means provided for covering the range. The circuit details are so nearly identical that but one diagram will be sufficient to explain the operation of both. This circuit diagram is shown as Fig. 4.

The unit around which the entire apparatus is built is of course the radio-frequency generator. This employs one 112-A tube in the well-known tuned grid circuit, and of course requires external sources to supply the filament and plate power. The first model of generator, shown in Fig. 1, has for its distinguishing feature an extremely wide range of carrier frequency. It has proven entirely satisfactory over the range 150 to 7500 kilocycles, and has in fact been operated at frequencies up to 13,500 kilocycles. However, at these extremely high frequencies the difficulties involved in accurate checking have prevented the making of a sufficient number of tests to be certain that operation in this region is entirely satisfactory.

Plug-in coils make possible the covering of this wide frequency range. Eight coils cover the range 150 to 7500 kilocycles with quite generous overlaps. A special feature of the design is that coils can be changed very quickly. Both the inner and outer

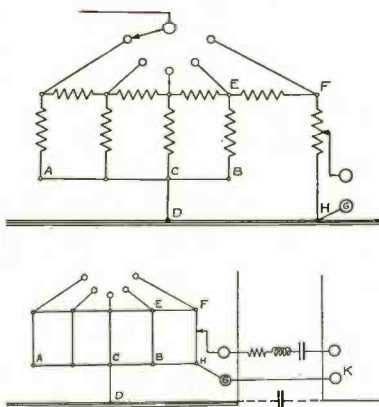

Fig. 5A
Fig. 5B
Sources of error in an attenuator system.

shields are provided with hinged lids. Since no screws or other fastenings need be removed the entire coil changing operation can be accomplished in ten to fifteen seconds.

The tuning condenser is operated by a worm drive similar to that used on precision wavemeters. This in effect provides a dial having 2500 divisions and makes possible a very accurate setting of the oscillator frequency. The frequency spread is sufficient to permit adjustment in the small steps used in selectivity measurements, thus eliminating the need for any form of separate vernier or fine frequency control.

The attenuator structure in this model required very careful design and construction to permit operation at the very highest frequencies in the range. Checks with other sources and methods have indicated that this has resulted in an absolute accuracy of output of quite a high order even at frequencies as high as 6000 kc.

The second signal generator, shown in Fig. 2, was intended for use only in the frequency range 150 to 1500 kc. This permitted the elimination of plug-in coils, since the entire range could be covered by the use of only two oscillating coil systems. These are both contained within the body of the instrument, each being enclosed in its own magnetic shield, and either is selectable by means of a control knob appearing on the front panel. The coil is connected to the tube, tuning condenser, and output circuits by means of a switch of the familiar cam-and-leaf-spring type, whose low losses and low electrostatic capacity make it suitable for this use.

The tuning condenser in this model does not have the worm drive for fine adjustment. Instead, each coil system is provided with a small rotor coil connected in series with the tuned coil, and rotatable from the front panel by means of another dial. The normal position for the coil is at right angles to the

grid coil. Rotating the coil in one direction decreases the total inductance of the tuned circuit and raises the carrier frequency while rotation in the other direction lowers the frequency. A variation of about five per cent plus and minus is obtained by proper proportioning of the numbers of turns on the coils.

Grid excitation for the oscillator is obtained through the usual condenser-and-leak series impedance, although the values of these are rather unusual ones for this use, as will be seen from the constants given on the circuit diagram. These values, as well as the various other constants of the circuit, were arrived at by an experimental process of design in which such features as frequency stability, constancy of output with frequency, low current consumption, and satisfactory modulation characteristics were the desiderata. Many of those named were found to be incompatible with others, the design thus becoming somewhat of a compromise between the various factors. The values finally arrived at give a degree of performance which is entirely satisfactory when used with the most advanced receivers being built at the present time.

Modulation System

The radio-frequency oscillator is modulated by inserting into its plate circuit, in series with the d-c. supply, an alternating voltage. This is accomplished by supplying the d-c. through the secondary winding of a modulation transformer, the d-c. resistance being kept low to reduce voltage drop at this point. The source of modulating voltage is connected to the primary of the transformer, and the resulting voltage at the plate of the radio oscillator tube is one which has both a-c. and d-c. components. The ratio of a-c. to d-c. volts is considered as being equal to the per cent modulation, this assumption being based on the fact that the modulation or input-output characteristic of the radio oscillator is very nearly linear. The d-c. component is read on the 150 v. d-c. panel voltmeter. This voltmeter indicates the battery voltage applied at the terminals of the generator, while the voltage actually appearing at the oscillator plate is smaller by the amount of the drop through the filter system and modulation transformer. However, by careful design this difference has been kept so small as not to affect the accuracy of the result greatly.

The alternating component of plate voltage is measured by means of a high resistance thermocouple voltmeter connected from the plate supply lead to ground through a condenser which keeps the d-c. out of the voltmeter but is large enough not to affect the a-c. reading even at frequencies as low

as 40 cycles. This a-c. voltmeter is calibrated in peak volts rather than r.m.s. volts. It is provided with a series multiplier whose total resistance is such that the scale indicated on the voltmeter becomes correct when the switch is set to the tap marked "100 per cent modulation." Thus, if the reading of the voltmeter is brought equal to the reading of the d-c. voltmeter, the peak of the a-c. wave will be equal to the d-c. voltage and the plate voltage of the oscillator will be 100 per cent modulated. For any other percentage of modulation the voltmeter multiplier switch is set to the desired tap, the resistance in circuit at this tap bearing the same relation to the total resistance as the desired percentage bears to 100. If then the input be readjusted to bring the readings of the two voltmeters again to equality, the modulation ratio will be the value indicated on the tap used.

The advantages of this system are that no calculations or interpolations are ordinarily necessary, sufficient taps being provided to cover almost all requirements. The percentage of modulation can be checked as often as desired, a mere glance at the panel serving to show whether or not the readings of the two meters are in equality. Further, the meter indication is always kept at the same part of the scale, so that small modulation percentages may be read as easily and accurately as large ones. Should it ever become necessary to use a modulation ratio not provided for by the switch a simple calculation and resetting of the a-c. voltmeter will make this possible.

The accuracy of the various percentages relative to each other depends only upon the accuracy with which the voltmeter multiplier resistances are adjusted. However, the absolute depth of modulation of the emitted wave is dependent upon the slope and linearity of the oscillator input-output or modulation characteristic. Since a certain amount of irregularity has unavoidably been permitted to exist here, the absolute modulation ratios may be in error by from five to eight per cent. These errors affect the output of the receiver in direct ratio and may therefore contribute errors of this magnitude to the final result. However, for ordinary purposes this error is entirely negligible. In a series of comparative tests it of course cancels from the results, while even for careful quantitative tests the error, while by no means small, is usually exceeded by other errors inherent in the apparatus or the method.

The oscillator characteristics vary with the oscillator circuit constants, and therefore the modulation depth errors vary with the output frequency. The lowest frequency in each range will usually be found to be the least accurate as to modulation. For example, the modulation depth being set to a

nominal 30 per cent by means of the panel meters, the actual modulation depth of the output wave was found to be almost exactly 30 at 1400 kilocycles, rising to almost 33 per cent at 600 kilocycles. There is also a slight variation in this factor between tubes and in a given tube during its life; it appears to be least for tubes of high conductance.

The modulating source may be either an external oscillator or the self contained oscillator. Throwing the modulation control switch to "Ext" connects the adjusting potentiometer, through a suitable filter to prevent radio frequency currents from leaking out at this point, to the panel binding posts marked "Ext. Mod." In the center position the input potentiometer is left unconnected so that an unmodulated carrier is emitted, while when the switch is thrown to "Int" the potentiometer is connected to the output of the internal oscillator and the filament circuit of this tube is closed so as to set it in operation. Only one frequency, 400 cycles approximately, is available from this internal oscillator, and its output, having purposely been kept small to minimize battery drain, is only sufficient for a maximum of 30 per cent modulation. This, however, is sufficient for about 90 per cent of the measurements which will be made with the generator.

Output and Attenuator System

The takeoff coils which are coupled to the main oscillating circuits of the generator have their turns and coupling so arranged that they provide a current of 100 milliamperes through a load of 15 ohms. Of this, five ohms are in the attenuator, five in the thermocouple, and the remaining five are supplied by the adjusting rheostat. This amount is provided to serve as a margin of safety to take care of variations of oscillator output due to battery aging and to changes of circuit conditions as the carrier frequency is varied over its range.

The current indicating device is a Weston Type 425 thermo-galvan-

ometer. In order to prevent radio-frequency potentials from appearing at the meter face the thermo junction is removed from the instrument case and mounted inside of the attenuator shield, filters being inserted in the d-c. leads to the indicating portion of the meter. The meter scale is then recalibrated, the deflection corresponding to a current of 100 milliamperes being indicated on the scale.

The attenuator proper is a five step constant impedance ladder type, the input to the net being connected to any desired step by means of the multiplier switch, which thus permits attenuation ratios of 1, 10, 100, 1,000, and 10,000 to be used. The last shunt branch of the system is a continuously variable slidewire potentiometer which permits intermediate values of output to be obtained. The scales of the two controls are marked in inverse attenuations so that the value of output voltage is obtained directly in microvolts by a simple mental multiplication of the two readings. The attenuator impedance being five ohms, a maximum of 0.5 volt is obtainable at the output terminals. The output impedance of the system, looking into the output terminals from the load, is variable, depending on the setting of the slidewire, and is equal to the slidewire reading divided by ten, in ohms.

It will be seen that we have exceeded the limit of two ohms which at the beginning we placed on the generator output impedance. This was necessary in order to obtain the additional output voltage over the .2 volt originally specified. However, since at this .2 volt output the generator impedance is actually only two ohms, the requirements have been met, in the spirit if not in the letter. It is possible so to use the generator that the impedance never rises above the two ohm limit, simply by staying below the "20" point on the output slidewire. Even the five ohm impedance, however, will not cause any appreciable error if care is taken that the load connected to the generator terminals is of sufficiently high impedance not to load the source. The artificial antenna commonly used, con-

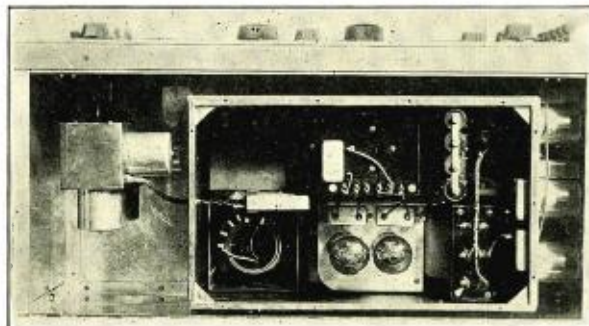

Fig. 6. Interior of 150 to 1500 kc. generator.

taining a 200-mmfd. series condenser, presents an impedance high enough to fulfill this requirement.

For some tests, notably those made upon detection systems, even the .5 volt maximum is not sufficient. A higher voltage than this can easily be obtained by utilizing a stage of radio-frequency amplification. One of the stages of the receiver under test can usually be made to serve very satisfactorily. If this is not convenient, a separate tuned circuit can be connected directly to the generator output, and the voltage developed across one of the reactances used as the high voltage source. Voltages up to 20 or 30 can be obtained in this way, but it is obvious that they must be measured by some external instrument such as a vacuum tube voltmeter, since the generator readings become meaningless under such load conditions.

The attenuator system has a usable range of output voltage of 500,000 to one microvolt. The absolute values of these voltages are set (or calibrated) by adjusting the current flowing through the attenuator to a value which will produce across the known resistance the desired value. In this case 100 milliamperes and five ohms are the values used. The accuracy with which the maximum voltage is known depends therefore upon:

A. The accuracy with which the current can be set to the standard value.

B. The accuracy with which the attenuator resistance is known. Since not strictly resistance, but rather impedance is the factor involved here, a knowledge of the frequency characteristics of the resistance structure used is implied.

When an output voltage less than the maximum is to be used another factor is involved:

C. The accuracy with which the attenuation ratios are known, including the number of ratios which must be used to obtain the desired voltage.

This last factor is by far the most serious limitation of the accuracy of the apparatus and will bear discussion in some detail. It is affected not only by the frequency characteristics of the resistance structures used in the attenuator but by all sorts of unsuspected stray couplings and leakages, the detection and elimination of which constitute a problem of considerable magnitude. It is not especially difficult to build resistance units which will be substantially free of inductive and capacitive effects, and it is very fortunate that in determining the resultant impedance of any element of the attenuator net, any reactive components must be combined vectorially and in quadrature with the resistive component. This means that, in series with a resistance of 5 ohms, an induc-

tive reactance of 0.5 ohms, instead of causing a ten per cent error, will cause an increase of impedance less than one per cent. The table below shows the inductance in microhenrys which approximately corresponds to the 0.5 ohm value at various radio frequencies. It is essential that the inductance of each 5 ohm unit be kept below these values if proper operation is to be obtained at the frequency considered:

Frequency, kc. . . .	100	500	1500	7500	15,000
Inductance, m.h. . .	.75	.15	.05	.01	.005

Practically, this means that inductances of leads which are normally not considered must not be neglected in the design of attenuators.

The inductances considered were those whose magnitudes would cause appreciable errors when connected in series with a single element of the attenuator net. When inductances become common to two or more elements, however, very much smaller inductances than those listed will cause more

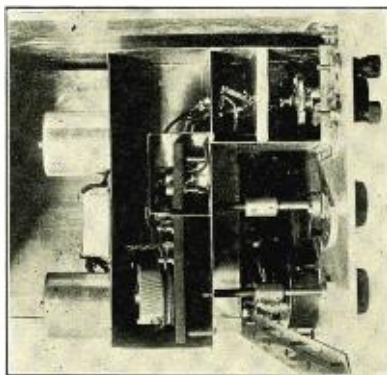

Fig. 7. Simplified attenuator structure in 150 to 1500 kc. generator.

serious errors. Fig. 5 has been drawn to illustrate how this can occur. The attenuator circuit considered is identical with that shown in Fig. 4, but the resistances are connected to ground in a different manner. The first four shunt branches are grounded to a metal sub-base, AB, which is in turn connected to the main base or panel through an impedance CD. If we assume CD to have an impedance of as little as 0.01 ohm, due perhaps to a wire one half inch long, or to a slightly high resistance structural connection, it will, with the attenuator switch in the position shown, have across it a drop of 1000 microvolts. Thus the last attenuator section EFH, which should be actuated only by a 500 microvolt drop in EB, will really be actuated by this amount in series with the drop in CD, causing an error which may be larger than a ratio of two to one.

If an attempt is made to eliminate this error by connecting the lower end of the slidewire FH to B instead of to

the main base a different type of error, which may be as great or greater than the first, will occur, as shown Fig. 5-B. The drop in FH is now of the proper value, but the voltage across CD acts through the distributed capacity between the microvolter case and the receiver case, producing a current which returns through the ground lead GK. The drop produced by this capacity current flowing through the impedance GK appears directly in series with the receiver input circuit, and thus may cause errors of many hundred per cent.

The proper solution, of course, involves making the impedance CD negligibly small—which, in the case of operation at 7500 kc. means smaller than 0.00005 m.h. inductive reactance. This is not easily done, even if the plate AB is placed directly in contact with the main base. A special arrangement of shielding to control the paths of the return currents has been found necessary to a practical solution of the problem.

The above examples are not in any way intended to be a complete summary of possible attenuator troubles. They are given merely to serve as examples of the difficulties encountered and of the magnitudes of the quantities which cause these effects. A great many of the faults of an attenuator structure will show up as stray or zero signal, an output voltage which appears at the receiver terminals when the microvolter output controls are set for nominally zero output. In the second case discussed, for example, the voltage drop in the ground lead GK will not be affected by the position of the output slidewire, and even with this control set at zero a very strong signal would still reach the receiver.

Of course, stray signals may also reach the receiver due to insufficient shielding of the generator or filtering of the supply leads. It is necessary to eliminate such strays before critical tests can be made on the attenuation system. The first step in testing a microvolter, therefore, is to make sure that the stray signal is negligible in comparison with the voltage being measured. If it cannot be made so, accurate results cannot be hoped for.

Checking Accuracy

The best method of checking the accuracy of a generator, after making sure that stray signals are negligible, is to check the ranges of the step attenuator against the slidewire. For instance, with the attenuator switch on x1 and the slidewire at full scale, a receiver connected to the generator is adjusted to obtain a given audio output. The attenuator switch is then placed on the x10 step, when the same audio output should be obtained with the

slidewire set at one tenth full scale. Similar checks are made between the other attenuator steps and at various radio frequencies in the range of the generator. Any difficulties due to reactive errors in the attenuator will show a systematic increase with increase of frequency.

Similar checks can be made on the type of microvolter using a fixed output resistance and variable attenuator current, but not as accurately. The meter cannot be read over a ten to one range, and even a comparison over a smaller range will in general involve one reading quite low on the meter scale where accurate observations cannot be made. A further difficulty with this system is that in general the change of attenuator current reacts upon the oscillator supplying the current, changing its oscillation frequency somewhat.

Another method of check is to compare the attenuator with an external attenuator, increasing the ratio of one while decreasing that of the other and observing any change of receiver output. This method sounds easy but it actually offers numerous chances for error. For example, the use of a capacitive attenuator appears very attractive, but is in practice very troublesome. The two main sources of error are:

- (1) Stray capacities in parallel with the low capacity unit.
- (2) Small inductances in series with the high capacity unit.

Unless great care is exercised to guard against these errors, very misleading results may be obtained. A resistance attenuator of 45 and 5 ohms in series is probably the easiest type to construct accurately, and will give satisfactory results if properly made. Finally, the acid test of all such checking methods is to try at least two different combinations or methods. Then if the results obtained from them do not check each other, both methods should be viewed with suspicion until the source of error is found.

In any event, a properly designed attenuator system will usually be found to give quite accurate results, at least insofar as can be detected in ordinary usage. Indeed, the checks which are obtained in normal use, when proceeding from one range to the next, are usually so close to the accuracy with which the test can be performed and the readings taken that the operator is led to believe that he is justified in reading the output dial to one per cent. He is, as a matter of fact, justified in reading it to this accuracy only when making such measurements as selectivity, over load, and stage gain, which are relative and comparative rather than absolute determinations.

In this connection it may be well to point out the fallacy of attempting to

obtain greater accuracy of measurement by operating the attenuator system at reduced values of current, commonly one-half normal. An analysis of the conditions, taking into account such factors as the greatly decreased accuracy and reliability of the current indicating meter, the load change which alters the oscillator characteristics, and the increased ratio between stray currents from the oscillator and the true attenuator current, will very quickly show that the net result is a serious loss of accuracy. The only benefit derived from the practice is an increased accuracy of reading of the output dials. This accuracy is already greater in most cases, however, than the known absolute accuracy of the instrument justifies.

Shielding

In order to prevent so far as possible the radiation of radio-frequency energy from any point other than the desired one, the output terminals, it is necessary to shield and confine the main oscillating circuits of the generator very carefully, and the attenuation circuits only slightly less carefully. The oscillating circuit coils, which are of course the source of the most powerful fields, are enclosed in a total of three separate shields, while the remainder of the oscillating circuit is shielded doubly and the attenuator in a partially separated double shield.

The oscillating coils are each enclosed in a small copper can shield which serves to confine the main magnetic field of the coil. These cans and the rest of the oscillating and modulating circuits which are at high r.f. potential are enclosed in a large box which is referred to as the main oscillator box. This is mounted on insulated pillars and all control shafts passing from it to the front panel have insulating couplings inserted in them. The object of the insulation is to prevent currents from circulating between the box and the panel and flowing through the face of the panel, setting up stray voltages and fields, and to insure that only one ground connection is provided for

the main box. This single ground is obtained through the Belden braid which surrounds the output leads supplying the attenuator current. Thus all ground and return currents are forced to flow out along this braid, surrounding the output leads (which are continuously transposed by twisting them around each other) and eliminating large current loops which might produce stray fields.

The physical relation of the various parts of the generator is shown by Fig. 6 which shows an interior view of the second (150 to 1500 kc.) type of generator.

Attenuator

The attenuator is contained in a copper box which serves both as structural support and shield, and which is laid out physically in such a manner as to control the paths of the currents flowing in it and to force them to flow concentrically around the path of the current in the attenuator proper, thus avoiding couplings between the known and unknown currents. The structure for the first type of generator is somewhat complicated. It is composed of three separate shield boxes, one within the other, each carrying a portion of the attenuator network and the associated currents, in order to prevent couplings between the high and low potential parts of the attenuator net.

In the case of the second generator, however, the decreased frequency range permitted a considerable simplification of attenuator structure, all of the parts being contained in but one copper box provided with internal shields to separate the various sections of the net. A side view of this simpler attenuator, with the side cover removed to show the relations of the various parts, is shown in Fig. 7. A feature of this construction is the easy access which it affords for adjustment or replacement of the slide wire. In the event of failure of the wire a new unit can be installed in two or three minute's time. This ease of replacement of the slide wire also obtains for the first type of generator although it is accomplished in a slightly

Fig. 8. Complete receiver testing setup in laboratory.

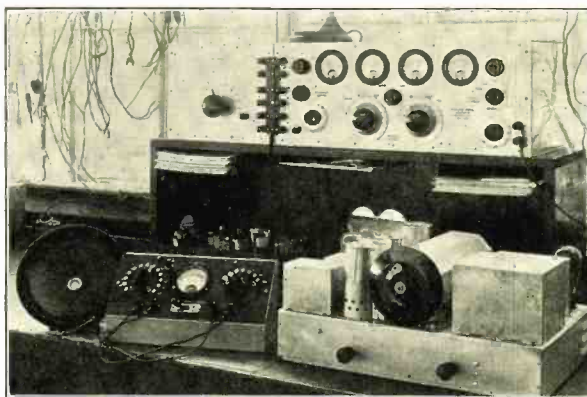

different manner. The complicated shielding of the attenuator prevents access from the side, so the entire slide wire unit is made to be removable through a large hole in the panel, this hole being covered by the slide wire dial in normal use.

Filters

Since practically every circuit element inside of the main oscillator box is at an appreciable radio-frequency potential to other elements and to ground, it follows that radio-frequency voltages appear on all of the leads entering and leaving this box for the purpose of supplying battery, modulating voltage, or the panel meters. These voltages must be removed before the leads can be exposed to the receiver circuits, to prevent the introduction of unknown voltages into the measuring circuits. Every lead is therefore provided with a suitable filter, excepting only the output current leads, which, in place of filtering, are provided with shielding.

The filters are of the familiar low-pass type in which inductance is inserted in series with the line being filtered and capacity is connected from line to ground. Most of these filters are very uncritical as to constants, it being necessary merely to use coils of convenient size and low d-c. resistance, and to provide capacities of a fairly large size. The filter constants used in the battery and output thermocouple leads were found experimentally to be adequate for these uses.

In the case of the modulation voltage input leads, however, another factor had to be taken into account, that of the efficiency and frequency characteristics of the filter, since it was desired to transmit all frequencies up to 7000 with little attenuation, and to work between impedances of the order of

5000 ohms. For this use a more careful determination of the constants of the circuit was necessary. Still another special case was that of the modulation voltmeter d-c. leads. The impedance of the battery lead filters is so low (25 ohms) that if used in the modulation circuit they would have presented an almost complete short circuit to the lower half of the high resistance thermo-couple used here, affecting the calibration seriously. For this reason a special type of filter was used, as shown on the circuit diagram. The capacity to ground was kept as low as was consistent with good filtering action, while the capacity across the two leads was made high in order that no radio voltages might appear across the meter terminals.

Miniature Portable Generator

The third type of microvolter is shown in Fig. 3. It was designed to be small in size, completely self-contained, and light in weight. The tubes used are the new 230 type, which can be economically operated from dry cells contained within the case of the instrument. The use of these smaller tubes will not permit obtaining as high an output as can be taken from the 112-A tubes. The maximum voltage is 100,000 microvolts, appearing across the same five ohm attenuator net. Since the oscillating circuit power appearing in the generator circuits is lower, the very complete shielding employed in the larger models can be partially eliminated. In this model the inner shield is not insulated from the outer case, permitting a much more rugged mechanical structure. Also, no battery circuit filters are required, although a filter for the external modulating voltage input circuit is provided to permit modulation from an external oscillator.



THE VARIABLE-MU TUBE AND DISTORTION IN RADIO RECEIVERS

(Concluded from page 30)

of curvature at values of S_m less than 100 rapidly diminishes. This happens at the same time that the input voltage E_g increases rapidly, so that the net result is a rapid rise in the distortion. In contrast to this, observe the gradual manner in which the slope of the 551 characteristic changes, and the much larger value of minimum radius of curvature. The radius of curvature is fairly large at low values of S_m , where the largest values of E_g are encountered. This is why the type 551 accomplishes such a large reduction in the distortion.

The reason for the peculiar shape of the type 551 characteristic is found in

the detail of construction of the control grid. The control grid is so designed that the amplification constant of the tube is reduced as the control grid bias is increased. The amplification constant varies widely and gradually over the range of grid-bias, and the term "variable-mu" has been applied to describe this feature.

Fig. 4 shows an input voltage transconductance characteristic for constant modulation rise. Under normal conditions a rise of about 20 per cent is allowable without introducing more than a negligible amount of distortion. Note particularly the large difference between values of allowable input voltage at high biases for the type 551 and type '24.

It will be seen that the lowest portion of the 551 curve in Fig. 4 corresponds

Only one meter is used to indicate both the modulating voltage and the radio-frequency current flowing to the attenuator. Two separate thermocouples are of course required, but the one indicating movement is used for both couples by means of a simple switching arrangement.

This model of generator was also desired to cover a large frequency range, and therefore the oscillating circuit coils were made plug-in. A worm-drive tuning condenser similar to that used in the larger generator is used here also.

Fig. 8, shows one of the larger generators as it is actually used in the laboratory. A small shelf or stand about fifteen inches high forms a very convenient mounting for the signal generator and its associated modulating oscillator. The generator is lifted up to a position where its dials are about on a level with the eyes of the operator, thus reducing reading errors and eye strain, while the bench top is left clear for the receiver under test, output meter, etc. A cable is provided to connect the generator to the battery box on the floor under the bench. Some installations have been made in which the plate voltage for the setup has been obtained from a generously designed "B substitute" power supply unit, and have given fair satisfaction. The poor voltage regulation of such devices is one of their chief disadvantages, especially where the external modulating oscillator is supplied from the same source.

Both of the larger generator models have been in almost constant use in the laboratory for somewhat over a year, and have proved to be very satisfactory under all operating conditions. No receiver has yet been encountered which could not be completely analysed by this type of generator.

nearly to the point of minimum radius of curvature in Fig. 3. Over the entire range of control, the type 551 introduces a smaller amount of distortion than its forerunner, the type '24. Because of this advance, as well as several more advantages described elsewhere, it is believed that the appearance of this invention of Messrs. Ballantine and Snow of the Boonton Research Corporation constitutes a definite step forward in the art of communication.



EFFECT OF THE MOON ON RADIO TRANSMISSION

In the July issue of RADIO ENGINEERING will appear an authoritative article dealing with lunar as distinguished from solar effects upon radio transmission.

Microphonic difficulties in the superheterodyne

By RINALDO DE COLA*

In Superheterodyne Radio Receivers Microphonic Regeneration May Be Due to Vibration of the Plates of Air Condensers

Introduction

SEVERAL years before the advent of the UY 227 type tube, a common affliction of many tuned radio-frequency receivers, and for that matter receivers of all types, was microphonic regeneration from tubes. This particular type of regeneration was concentrated in the audio-frequency tubes, and frequently in the detector. This greater susceptibility in the detector tube was, of course, due to its correspondingly greater sensitivity and to the fact that it operated as a detector. Experience has shown and theory of thermionic circuits substantiates, that in no case when the radio-frequency amplifiers are considered, can microphonic regeneration take place. Microphonic regeneration, as considered in this paper, is that type of regeneration due to the mechanical vibration of elements within the receiver, which causes a sustained constant sound to be emitted from the loud-speaker, this sound being transmitted back to its source through the cabinet walls, or through the surrounding atmosphere, and since it is of the same phase as the original sound, consequently reinforces and sustains the oscillations. This microphonic regeneration is, of course, very objectionable in any radio receiving set. However, after the introduction of the UY 227 radio tube for commercial purposes this type of regeneration was, as far as radio tubes were concerned, completely eliminated. It has become a part of radio history.

Theory

From the foregoing it is indicated that so far as tubes are concerned in the tuned r-f. receiver, microphonic

regeneration can be dismissed. That such is also true for variable condensers in t.r.f. tuners will also be shown. That such is generally the case will be proven in the theoretical discussion to follow.

The only type of radio receiver which is susceptible to microphonic regeneration due to vibration of variable air condensers is the "double detection" or superheterodyne receiver. This is true because of the tuned oscillator circuit in such a receiver.

In the superheterodyne receiver we will consider the received signal to be of frequency ω and the oscillator frequency as a higher value of frequency ω_1 . This point for the oscillator frequency is merely taken for illustration. Equal results would be obtained if a lower value of frequency were utilized. The beat frequency of course will be the difference between these two frequencies. Hence we obtain for the value of the intermediate frequency,

$$\omega_{11} = (\omega_1 - \omega) \tag{1}$$

We can further define ω_1 and ω as

$$\omega_1^2 = \frac{1}{L C_1} \tag{2}$$

or

$$\omega_1^2 = \frac{\pi}{C_1} \tag{3}$$

where K is equal to $1/L$ and

$$\omega^2 = \frac{K}{C} \tag{4}$$

Since the value ω is the transmitting station frequency and cannot be changed at the receiving end it will be considered a constant. Hence the only available manner to change ω_{11} the intermediate frequency is by carrying ω_1 , the oscillator frequency. The term $1/L$ in this case also is a constant. The only remaining possible way to carry ω_1 is by varying the value of the oscillator variable condenser C_1 . Considering a small change

ΔC_1 in the oscillator condenser the change in the intermediate frequency will be,

$$\Delta \omega_{11}^2 = \left[\omega_{11}^2 - \left(\frac{K}{C_1} + \frac{K}{\Delta C_1} \right) - \frac{K}{C} \right] \tag{5}$$

more simply perhaps,

$$\Delta \omega_{11}^2 = [\omega_{11}^2 - (\omega_1 + \Delta \omega_1)^2 - \omega^2] \tag{6}$$

In the case of an oscillator condenser whose plates are vibrating, due to mechanical feedback in the cabinet in which the receiver is assumably mounted, this vibration is harmonic, and can be expressed as,

$$D_x = D_o \sin \omega T \tag{7}$$

where D_x is the instantaneous displacement of the condenser plates. D_o , the maximum value of the displacement. The term $\sin \omega T$ determines the rate of vibration.

It must of course be understood that in order that there be a change in the condenser capacity due to this vibration either the rotor or the stator plates of the condenser must be assumed at rest. If both condenser units vibrate in synchronism there will be no variation in capacity. Hence a microphonic voltage cannot be generated. However, complicated cases may arise where one set of plates is vibrating at a different frequency than the others and is not at rest. Such a condition still leads to microphone action, however, and we will, for simplicity in this paper, consider that one set of plates is stationary while the others are going through the harmonic action.

We will also, for the sake of simplicity, consider only a unit area of the variable condenser as being in motion, as this will simplify the solutions considerably.

Since C_1 is the normal value of ca-

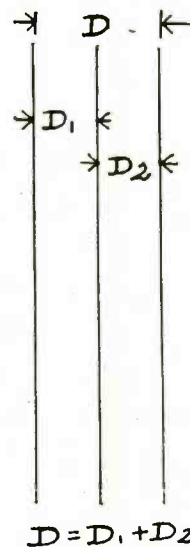

Graphic presentation of equation 8.

$$C_1 = \frac{1}{D_1^2} + \frac{1}{D_2^2}$$

* Chief Engineer, Victoreen Radio Co.

capacity for the oscillator condenser, this can be represented as

$$C_1 = \frac{1}{D_1} + \frac{1}{D_2} \quad (8)$$

A study of Fig. 1 will prove the above relation.

Expressing the distances D_1 and D_2 in terms of D gives the following value for C_1

$$C_1 = C_a + b = \frac{1}{(D - D_2)} + \frac{1}{(D - D_1)} \quad (9)$$

From (6) and (9) we obtain for the instantaneous value of C_1 when the rotor plates are vibrating, (we are assuming that the rotor plates alone are vibrating since this is nearly always true) at the rate shown in equation (7) or, $\sin \omega T$.

Since the harmonic motion as considered for each plate is 180 degrees out of phase the value of the term D_x for each plate is expressed by

$$D_x = D_0 \sin \omega T \quad (10)$$

and

$$D_x = D_0 \sin \omega T + \pi \quad (11)$$

then

$$C_1 = C_a + b = \frac{1}{(D - D_2 + D_0 \sin \omega T)} + \frac{1}{(D - D_1 + D_0 \sin \omega T + \pi)} \quad (12)$$

which value gives the instantaneous value of C_1 . Then from (3) and (10).

$$\omega_1^2 = [K(D - D_2 + D_0 \sin \omega T) + (D - D_1 + D_0 \sin \omega T + \pi)] \quad (13)$$

which gives the instantaneous value of ω_1^2 , which is expressed in (13) as ω_2^2 . An inspection of equation (13) will show that for values of the sine terms equal to zero the value of ω_2^2 can be expressed as,

$$\omega_2^2 = \omega_1^2 \quad (14)$$

However, when the sine terms in (13) are equal to the value for a 90 degree angle for the first sine term and the value for a 270 degree angle in the second sine term the value for ω_2^2 will become,

$$\omega_2^2 = \omega_1^2 - \Delta \omega_1^2 \quad (15)$$

The value $\Delta \omega_1^2$ is the term with which we are chiefly concerned since upon its value depends the frequency of the microphonic voltage. This term is only of interest when it falls in the audio-frequency range since it is then that its presence is annoying. Hence since the value of ω_1^2 is variable between the maximum values,

$$\omega_2^2 \text{ and } \omega_1^2 - \Delta \omega_1^2$$

we obtain for (1),

$$\omega_{11} = [\omega_1 - \sqrt{K} \sqrt{(D_0 \sin \omega T + D_0 \sin \omega T + \pi)} - \omega] \quad (16)$$

Which is equivalent to a frequency modulated wave ω_{11} at the audio frequency, equal to the term,

$$\Delta \omega_1 = \sqrt{K} \sqrt{(D_0 \sin \omega T + D_0 \sin \omega T + \pi)}$$

from equation (16).

From the above it will be evident that in order to keep the tendency to microphone down to a minimum in a radio receiver the quantity in (15)

$\Delta \omega_1^2$ must be kept as small as possible.

At this point we will further investigate (9). Which is here shown again for convenience.

$$C_1 = \frac{1}{(D - D_2)} + \frac{1}{(D - D_1)}$$

Differentiating,

$$\frac{dC_1}{dt} = \frac{1}{(D - D_2)^2} + \frac{1}{(D - D_1)^2} \quad (17)$$

Then to find minima for C_1 . Since $(D - D_2)^2$ is equal to D_1^2 , and $(D - D_1)^2$ is equal to D_2^2 , then

$$\frac{2}{D_1^2} + \frac{2}{D_2^2} = 0$$

and

$$D_1 = D_2 \quad (18)$$

Thus it can be readily seen from (18) that for the minimum tendency of the oscillator condenser to microphone the value for C_1 for the condenser must be a minimum which is obtained when the distances shown in Fig. 1, as D_1 and D_2 are equal. The foregoing analysis has thus indicated that for minimum tendency to microphone in a superheterodyne receiver, this microphonic voltage originating in the oscillator condenser, the condenser must be so constructed that the amplitude of vibration (equation 16) must be kept to an absolute minimum and that the rotor plates in the condenser must be located in the exact center of the stator plates at which point the minimum rate variation takes place in C_1 for any given value of D_0 in equation (7).

General

The foregoing analysis has dealt solely with the effect of the vibration of the oscillator condenser. However, there are many points in the mechanical construction of the condensers and possibly circuit arrangements and constants that go far to reduce the tendency to reduce microphoning. These will be discussed in the following paragraphs.

It has been found that if the oscillator energy feeds into the first detector and it is not made much larger than the amount of energy in the detector due to the received signal in this circuit the tendency to microphone will be proportionately reduced. This is due to the fact that usually a relatively large voltage is fed into the detector from the oscillator which does not materially help the sensitivity of the receiver but which increases the tendency to microphone to a much greater extent. This, of course, is based on the well-known fact that if two sinusoidal e. m. f.'s of different frequencies are made to beat, the total amplitude of the beat signal resulting therefrom cannot exceed twice the amplitude of the weaker signal. In ordinary receivers the amount of energy from a broadcasting station in the first detector is not very large, even on powerful local stations, but on the other hand the amount of energy induced

into this circuit from the oscillator is proportionately much larger. This condition only aggravates the tendency to microphone and does not materially aid the sensitivity of the receiving device.

It has been found that unless the detector circuit of a superheterodyne is very close to the point of oscillation it does not have any tendency whatever to microphone. This is also true of any r-f. stage which may precede the detector. That this is also true of all t. r. f. receivers is readily evident.

Using commercially accepted radio tubes, no difficulty whatever has been encountered from microphoning from this source.

The use of metal in condenser plates which possess very little ability to transmit vibrations is of paramount importance. If, for instance, one used condenser plates made of brass, which is an excellent vibration transmitter, the receiver will not respond to the most energetic efforts to eliminate microphoning. But, on the other hand, if one uses a relatively poor transmitter of mechanical vibrations, such as aluminum, the difficulty will be reduced tremendously.

A. J. CARTER WORLD'S FAIR RADIO COMMITTEE CHAIRMAN M. F. FLANAGAN, SECRETARY

"NICK" CARTER, president, Carter Radio company, and vice-president, Utah Radio Products, has just been appointed chairman of the Radio Industries committee of the Chicago World's Fair.

Col. J. Franklin Bell, Chief, Applied Science and Industry division of the Fair, made the selection of the veteran radio manufacturer, whom all radio men know as one of the four founders of the Radio Manufacturers Association.

The industry, according to Mr. Carter, is to have a place of major importance among the "live" exhibits at the exposition, which is expected to draw 350,000 visitors daily during its run of five months, June to November, 1933.

M. F. Flanagan, executive secretary, Radio Manufacturers Association, is Mr. Carter's first appointment. He will serve as secretary of the Radio Industries committee. A strong and vigorous membership of leading radio manufacturers will complete the personnel of the committee and guide its destinies.

CONSTRUCTION OF HAWAIIAN INTERISLAND RADIOTELEPHONE SYSTEM BEGUN

The Mutual Telephone Co. has begun actual construction of the interisland radio telephone system on four islands and installation of a new land telephone system on the island of Molokai.

Typical public-address installations

By HENRY L. WILLIAMS

Although the Requirements for Each Installation Are Special, There Are Various Fundamentals Common to All.

WHEN municipalities or public authorities want a public-address or centralized radio system installed they usually retain an engineer to draw up definite specifications. Private concerns, on the other hand, generally leave the layout to the individual contractor, so that each sound engineer designs his own system and the resulting estimates may vary as much as 100 per cent.

This is one of the reasons why the sound installation concerns should have a really competent engineer on the staff, even though they specialize in the use of factory-built equipment. On the sound-producing capacity of the equipment depends the price, and efficiency often governs the capacity of any unit. An inefficient layout therefore usually costs more than it should—if the contractor is fortunate enough to get the job.

The necessity for careful planning of an installation is well illustrated in the following example.

The requirements under this contract were a p-a. system to cover a new ball-park seating 35,000 people. As the park was also to be used as a football field, a second position was designated for the microphone, which therefore had to be movable. Both radio and phonograph had to be provided so that they could readily be controlled by the announcer.

The real problems of this installation were introduced by the fact that the speaker assembly had to be mounted at a considerable distance from the announcing points—raising questions of voltage drop and efficient impedance relations.

As the sketch-plan, Fig. 1, shows, the speakers were to be mounted on the 120-

foot lighting tower. As it was proposed to use a certain make of horns, these were drawn to scale on the park elevation and plan blueprints. Accurate projection of the sound beams, both horizontally and vertically, showed that the most efficient height for these horns was a little over 65-feet, and that six of them would be required to give the necessary spread.

The next problem was to decide on the most efficient arrangement of the amplifiers. It was determined that the utmost in flexibility could be secured—allowing for future expansion—by using one PAM-5a voltage amplifier (consisting of a type -27 tube working into a pair of -45's) feeding three PAM-25a power amplifiers (two -27's and two -50's, both push-pull). These three output stages would each work into two

dynamic speakers, allowing about 75 watts undistorted output per speaker.

A controlling factor, however, was the long run of the voice lines from the microphone. Naturally, the two-stage microphone amplifier had to be located close to the microphone, as the distance from the mike to the speakers was either 800 or 1100 feet, dependent on whether the game was baseball or football. After due consideration, it was decided to use a 60-ohm line between the mike amplifier and the voltage amplifier, and to locate the latter as near the speakers as possible. Low capacity lead-sheathed twin cable was adopted throughout, having a d-c. resistance of about 5 ohms per 1000 ft. The final arrangement therefore was to house the main amplifiers in the base of the lighting tower—for which purpose a room was built—and to work direct from the amplifiers into the speaker voice coils. This of course necessitated using output transformers having two 15-ohm windings, or rather, less.

This arrangement resulted in the use of six separate pairs from the amplifiers to the speakers. This was considered a better arrangement than putting the voice coils in series, as in case of breakdown each line could then be checked separately.

A refinement introduced here was the installation of an impedance plug panel which enabled each voice coil circuit to be opened and an impedance of equal value substituted in the feed line, by means of an ordinary plug. Thus, should a voice coil burn out, it could readily be detected and the impedance substituted. The length of the 15-ohm lines, it will be noted was but 60-feet.

In order to minimize the possibility of having to service the speakers on the mast, the standard dry rectifiers were removed and the fields supplied from a tube-type rectifier assembly in the

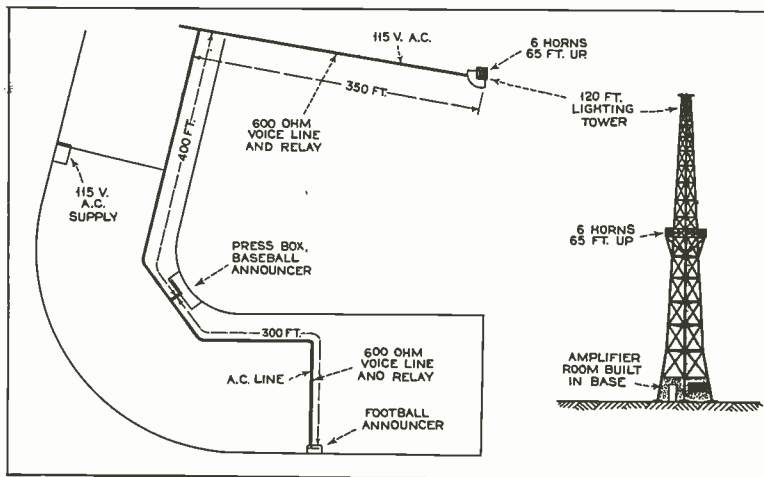

Fig. 2.

Fig. 1.

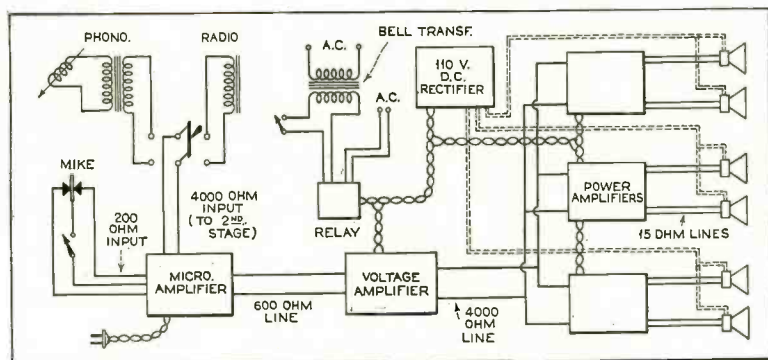

Fig. 3. Amplifier layout.

amplifier room, using pairs of type -81 tubes for full-wave rectification.

Announcing Equipment

As the microphone assembly had to be portable, it was necessary to house the mike amplifier in a suitable carrying box, with plug receptacles for the phonograph and radio, and a simple switching arrangement. All that the announcer had to do then was to detach his a-c. and line cords. A special small bakelite panel was built into the end of this box to carry the switches, and indicator lights were provided to show what was "on" and what was "off." A switch on the plug panel in the press box where the announcing was done, cut out the dead end of the line when the remote position was not in use.

On the same panel was incorporated a momentary-contact switch which operated a relay in the amplifier room and threw the a-c. "on" or "off." With

this arrangement, the announcer could operate the entire system from the press box or the football announcing booth, and it was unnecessary to enter the amplifier hut.

In distinct contrast to this job as to the problems involved, was a small ship installation. This installation, which was duplicated on another boat, consisted of four dynamic speakers built into the panelling of three public rooms—the smoke-room, observation room, and dining saloon. Music is provided by a phonograph and radio receiver, with centralized control of volume. The receiver used is the latest type superheterodyne having a pair of -45 tubes in the output stage. This, of course, was not quite sufficient output for the four speakers, giving but a little over 1 watt per speaker. A separate output stage of push-pull -50's therefore was built up in this installation from AmerTran parts, with its

own power supply. It was considered quite unnecessary to go to the trouble of altering the -45 stage to -27's as there was ample gain in the -45 stage to produce maximum grid swing on the -50's.

As the ship's supply was 115-v. d-c., a converter was supplied to transform this into 110-v. a-c. Some temporary difficulty was experienced with this 350-watt converter due to the hum of the armature. The converter was installed in the engine room, yet the faint whine was audible two decks above at the radio input. Mounting the converter on springs eliminated this, while the abolition of the frame ground also helped.

All speaker fields, which were designed for 100-v. d-c., were fed from the distribution box at the radio so that they were automatically switched off with the radio.

Multiple Speakers

Another minor problem that promised to give trouble was the method of splitting the output among the three speaker circuits, each being handled by a separate volume control. The first method tried was to insert an output amplifier having a separate secondary winding for each speaker circuit. This however did not give the quality desired. The arrangement finally adopted consisted of using the original speaker input transformers removed from the speakers and mounted on the amplifier. The quality was then excellent, regardless of the position of the various volume controls. Packard No. 77 cable was used for voice lines throughout.

VACUUM TUBES OPERATE ELEVATORS

THREE element tubes, similar to radio tubes, are employed in the control of automatic elevators. These tubes really act as the "human agency" carrying the signal that informs the control machinery as to when to stop the elevator. In the usual set-up, several tubes are mounted on each elevator car, normally in oscillation. By a special arrangement of coils and vanes, the motion of the car is made to stop the oscillation of the tube, thus actuating relays which in turn govern the control circuits that slow up the car and stop it at the desired position.

Other Uses

The use of vacuum tubes in engineering and research laboratories is increasing every day. Outstanding in their present-day application, are: for measurement of high-frequency currents of small magnitude—the instrument employed is known as a vacuum tube voltmeter; for creating sound waves of any desired frequency or in-

tensity—a device known as an audio frequency oscillator is here utilized; for producing radio frequency signals of any desired wave length—this is performed by an instrument called a radio frequency oscillator, one of its most important uses being in the efficiency testing of radio receivers.

GROUP AUDIENCES

AN interesting psychological fact with respect to the growing "pulling power" of radio programs coincident with the improved quality of broadcasting being evidenced, is pointed to by D. F. Ketcham of the Sales Promotion Department of E. T. Cunningham, Inc., who gives it as his opinion that radio is becoming less and less a matter of mass entertainment and developing steadily into small selective groups with specialized tastes.

In the not recent past, he states, radio entertainment was merely a background for the evening's activities. Now, however, he believes that the high quality of musical and educational features

provided is dividing the listener audience into various selective groups, with the radio program constituting the "star" role of each group's activities.

"There is no doubt," he concludes, "that such selective listening is adding immeasurably to the potency of radio as a dominating factor in the aesthetic, cultural and educational life of our American citizenship."







WAGES PAID TO RADIO OPERATORS ON GERMAN SHIPS

The monthly wage paid to German radio operators, as of January 1, amounts to \$81.20 for ocean voyages. The wage rate on vessels plying between German ports and ports of Great Britain and Ireland are approximately ten per cent less than on ocean voyages, while the wage scale on vessels plying between German ports and those on the Baltic and North Sea are approximately 20 per cent less than on long runs. (*Vice Consul Sabin J. Dalferes, Hamburg, Germany, 4/16/31.*)

YOU WOULDN'T TOLERATE A BRITTLE ROD



*How do your customers
feel about brittle insulation?*

IF the insulation in your products breaks under use, it's worse than useless — it's not  dependable. That means returned goods and dissatisfied customers. » » » Why take unnecessary chances when you can be sure by using Synthane  Laminated Bakelite? It's dependable. You know that in turn your products are  dependable — that your customers will be satisfied. » » » In addition to resiliency and structural strength, Synthane has many other superior features, both electrical  and physical, which we will gladly explain to you. It is made only of the finest materials,  giving you only the best results. » » » Your customers will not tolerate brittle insulation any more than you would tolerate a brittle fishing rod. » » » Be  sure — use Synthane. Generous samples for testing sent on request. Synthane Corporation, Oaks, Pennsylvania.

SYNTHANE
Laminated Bakelite

NEW YORK • CHICAGO • PHILADELPHIA • DAYTON • LOS ANGELES • SAN FRANCISCO

The properties of insulators

By EDWARD LUPTON, D.Sc., Ph.D.

THE various classes of insulating materials are as follows:

Solids.

- Natural: Gums and resins, wood, marble, slate, asbestos, etc.
- Manufactured: Paper, vulcanite, glass, moulded compositions, porcelain, etc.
- Plastics: India rubber, gutta-percha, pitch, waxes, etc.

Liquids.

Solidified on application: Varnish, shellac, paint, enamel, etc.

Gases.

Atmospheric air and some other gases.

Desirable Properties

The desirable properties, electrically, are:

- a. High resistivity.
- b. Small surface leakage.
- c. Great disruptive strength.
- d. Low power factor.
- e. Low dielectric hysteresis.
- f. Low dielectric absorption.
- g. Small temperature coefficient of resistance.
- h. Low dielectric constant (for high frequency work).

The mechanical properties are obvious, and comprise great strength (tensile, compressive and shearing), non-brittleness, ease of working, etc.

Some of the requirements for electrical uses will now be explained.

(a) *High resistivity.* Resistivity or specific resistance is the reciprocal of conductance, and so, as high conductance is necessary for the connecting leads, low conductance is required for the insulating materials. This applies to both low and high frequencies.

(b) *Small surface leakage.* In most insulators the resistance of a solid block of the material to current is far higher than the resistance of a surface of the material in contact with air. This is because the surface in contact with air is more or less moist, and attracts dust and other conducting particles from the atmosphere.

A satisfactory insulator must therefore have a low surface leakage. The case of moulded insulators is an illus-

tration. The gap between the two metal bolts may be only about half an inch, but the surface length from bolt to bolt is several inches.

The surface resistance is necessarily dependent upon the condition of the air in contact, and is low in humid air and much higher in very dry weather. For both low and high frequencies the surface leakage should be small.

(c) *Disruptive strength.* The disruptive strength of a material is its ability to withstand actual physical breakdown caused by electrical means. When a solid insulator has a potential applied to it which is gradually increased, the material will break down at a certain voltage and be either punctured or smashed.

(d) *Power factor.* The power factor for a vacuum is zero, and for atmospheric air is negligible. For solids the power factor is not negligible,

One of the most important studies for radio work is that of insulators.

and as it leads to waste of power it should be as low as possible. This is especially important in condensers for high frequency.

(e) *Dielectric hysteresis.* Dielectrics other than air do not acquire their charged condition immediately a potential is applied. The lag of the resultant charge with the applied potential is called dielectric hysteresis, and is similar to magnetic hysteresis in iron.

In common with power factor, it is objectionable for high frequency insulators and condensers.

(f) *Dielectric absorption.* A condenser with a dry air dielectric is practically perfect, as it has negligible power factor and dielectric hysteresis and a high disruptive strength. Further, when it is discharged the charge is neutralized immediately. With other dielectrics the charge is not

all gotten rid of at once. If the condenser is shorted and then insulated, most of the charge will have been neutralized, but on shorting again after a minute or two another discharge, smaller than the first, will take place. This is due to dielectric absorption, or soaking in of the charge. Similarly, on charging for a long time the condenser will acquire a greater quantity of electricity than if it is charged for an instant only. For air condensers there is negligible absorption.

(g) *Temperature coefficient of resistance.* Most conductors increase their resistance with an increase of temperature. An exception is carbon, which decreases. Thus carbon is said to possess a negative temperature coefficient. As some insulators are organic they are similar to carbon in having a negative coefficient, while others are positive. If a resistance is tested at two different temperatures the resistance found each time will be different, due to this cause.

(h) *Dielectric constant.* The dielectric constant or specific inductive capacity of free air is considered as unity, and all others are expressed in terms of this. If an air condenser has its air spaces filled with another dielectric the capacity of the condenser will be increased. The ratio of the capacity of the condenser with the material as dielectric to the capacity of the same condenser with air as dielectric, is called the dielectric constant of the material, and will not vary from a given sample of the substance under the same conditions. For insulating work this should be low, as at high frequency a given capacity passes more current than at low frequency. A panel made with a material of dielectric constant of ten will therefore have ten times the stray capacity of one with a material of dielectric constant unity. (Actually, only air and some other gases have values as low as 1.) For dielectrics in condensers the case is different, and the size of a given condenser will be reduced by using a material of high dielectric constant. The material used, must, however, satisfy the conditions in the above list of properties as well, and in general no one substance will satisfy all the conditions.

Some values of the above constants for different materials are now given.

Resistivity

	Ohms per cubic-centimeter.
Mica, greater than.....	8.4×10^{13}
Micanite, greater than.....	249.0×10^{13}
Shellac, greater than.....	900.0×10^{13}
Hard rubber, greater than.....	2800.0×10^{13}
Paraffin wax, greater than.....	3.0×10^{16}
Quartz, greater than.....	1.2×10^{18}
Marble, greater than.....	1.0×10^9

These are given as the resistance between opposite faces of a cube of one-centimeter sides. Actually, they are measured with a different size, in which



SOME LOUD SPEAKERS LOSE THE HIGH NOTES



THE LOW NOTES ARE LOST IN OTHERS



MANY COMPROMISE ON THE MIDDLE REGISTER



BUT ONLY MAGNAVOX GIVES YOU FULL SYMPHONIC TONE RANGE

THE NEW MAGNAVOX "140" SYMPHONIC SPEAKER HAS BECOME A SENSATION OVERNIGHT —AND AN INSTANTANEOUS SUCCESS. NEVER BEFORE HAS A SPEAKER OF SUCH SPLENDID VOICE AND STURDY CONSTRUCTION BEEN AVAILABLE AT SO ATTRACTIVE A PRICE. . . . MANY OF THE BETTER SETS EXHIBITED AT THE TRADE SHOWS FEATURE THE NEW MAGNAVOX. IT CAN NOW BE FURNISHED IN THREE MODELS: THE "140" WITH SIX AND THREE-QUARTER-INCH CONE; THE "142" WITH EIGHT AND ONE-QUARTER-INCH CONE; THE "143" WITH TEN AND ONE-QUARTER-INCH CONE.

SEE THE NEW MAGNAVOX SYMPHONIC SPEAKER AND THE NEW MERSHONS AT THE R. M. A. TRADE SHOW AND THE I. R. E. CONVENTION



Magnavox Company Ltd.

Executive and Sales Offices:
'155 East Ohio St., Chicago, Ill.

Factories:
Fort Wayne, Ind.



Subsidiaries:
The Magnavox Company
Electro Formation, Inc.
Magnavox (Great Britain) Ltd.
Magnavox (Australia) Ltd.

Magnavox SPEAKERS

THE PRODUCT OF TWENTY YEARS' PIONEER RESEARCH

surface leakage is eliminated. Surface leakage is not a constant, and cannot be tabulated.

Disruptive Strength

No figures are given for the disruptive strengths of various materials, since these figures seem to vary to a large extent with different samples, particularly for the naturally occurring insulating substances.

Power Factor

The power factor is less than 1 per cent for the following: Dry paper, paraffin wax, mica, hard rubber, india rubber, and vulcanized india rubber.

It is less than 2 per cent for glass and gutta-percha.

Dielectric Constants

Air, dry, at 760 mm. pressure	Unity
Hard rubber	2.5—3.5
Glass, light to very dense	6.5—10
India rubber	2.3—3
Mica	6.6—8
Paraffin wax	1.9—2.5
Shellac	2.7—3.7
Quartz	4.5

Some of the insulating substances have been omitted from these lists where serious discrepancies exist between the published figures for the various constants.

Consideration of Some Insulators

Paraffin wax.—This is one of the best insulators, when it can be used. For research work where the minimum leakage of current is essential, all the insulation is of wax; hard rubber and mica are far too low in their resistivities, both volume and surface.

Hard rubber. The best is a good insulating material, the worst is very bad. As made, it is usually coated with finely-divided tin-foil, which is used in its manufacture.

This gives a bright, shiny appearance, which is often referred to as "polish." The tinfoil makes its surface conducting, and so if used like this the leakage will be considerable, although the actual insulation through the material may be very high.

It is often stated that the matt-surface hard rubber is the best for insulation. This is not necessarily so, and correctly polished hard rubber is usually more satisfactory.

It should be noted that in all high-class electrical instruments the hard rubber is invariably polished.

This polished surface must not be confused with the tinfoil surface which is present when the hard rubber is bought.

Mica and micanite. Mica is a natural mineral and has good insulating properties. It is liable to have conducting veins running through it, which somewhat reduce its value.

Mica is difficult to obtain in large

sheets, and so for work requiring large pieces micanite is used.

Mica easily laminates, and a piece can usually be split up into laminae of less than a thousandth of an inch thick.

Construction of Micanite

To make micanite, mica is laminated and the small pieces are stuck together with hot shellac varnish. While the micanite is hot it can be bent into various shapes, and is often made into tubes while hot, so that when cold a firm, hard tube of insulating material results.

This process avoids the metallic veins becoming troublesome, as they become separated on lamination.

Wood. Hard, dry woods may often be used even for radio work. It is essential to use dry wood, and the hard woods are much more satisfactory than soft.

Before use it is best to soak the previously-warmed wood in molten paraffin wax until bubbles cease to rise. The wood, when cold, will then be of high resistance, both volume and surface, and will resist moisture on its surface.

Marble and slate. These are used very little in radio work, but in low-tension electrical engineering they are invaluable.

To summarize, it is only necessary to point out that for certain radio purposes air is the best insulator, when it can be used, owing to its negligible power factor, hysteresis, etc., and low dielectric constant.



BUENOS AIRES AN IMPORTANT INTERNATIONAL COMMUNICATION CENTER

Direct radiotelegraphic communication with Amsterdam, Holland, was established by the Transradio Internacional on February 2. This company has secured a contract from the Dutch authorities for the exploitation of the system and will work the circuit in conjunction with the direct services to the United States, Great Britain, France, Germany, Spain, Italy, Brazil, Chile and Paraguay. Radio telephone service between Australia and Argentina, Uruguay and Chile was opened on April 8, using the radiotelephone circuit which the International Telephone and Telegraph Corporation operates, in conjunction with the British Post Office, between Buenos Aires and Rugby, England, and the circuit operated by the British Post Office at Rugby and the Amalgamated Wireless Co. at Sydney, Australia. In Buenos Aires this circuit will connect with the lines of the United River Plate Telephone Co. which operates the most extensive telephone system throughout the Argen-

tine, and also connection will be made with the modern international telephone circuits which run under the River Plate to Uruguay and across the Pampa and over the Andes Mountains to Chile, this last forming the highest international telephone line in the world.

Plans now rapidly approaching conclusion will bring the telephone services of Bogota and Rio de Janeiro into direct touch with local circuits. Two new wireless-telephone transmitting stations and two receiving stations are now under construction at Bogota and Santiago, Chile, respectively, and equipment for a new circuit is being installed in the stations at Hurlingham and Platanos, near Buenos Aires. The sending and receiving stations under construction in Rio de Janeiro by the Compania Radio Internacional de Brazil are being prepared to work with those of the Compania Internacional de Radio (Argentina) in Buenos Aires and the Compania Internacional de Radio (Espana) in Madrid, as well as to provide direct service with the United States. (Assistant Trade Commissioner Charles H. Ducote, Buenos Aires, 2/13/31.)

AUTOMOBILES DISTURB TRANS-OCEAN RADIO RECEIVERS

While horse drawn vehicles are generally considered a relic of a less scientific era, they have not merely survived the obliterating movement of a machine civilization, but are necessary to its efficient functioning, as a means of transportation in the vicinity of the commercial receiving stations, where telephone calls from Europe and South America are rerouted over the telephone lines to subscribers in the United States.

Interference caused by automobile ignition, which contributes no small portion of the annoying background noise of broadcast program reception, cannot be tolerated in a commercial telephone circuit, and there is a zone, surrounding the Bell Telephone receiving stations at Netcong, New Jersey, inside of which no automobiles are permitted, other than official cars with shielded ignition systems. These receiving points have even been located away from airplane routes in an effort to avoid background noise, and much of the transportation at the station depends on the horse and wagon.

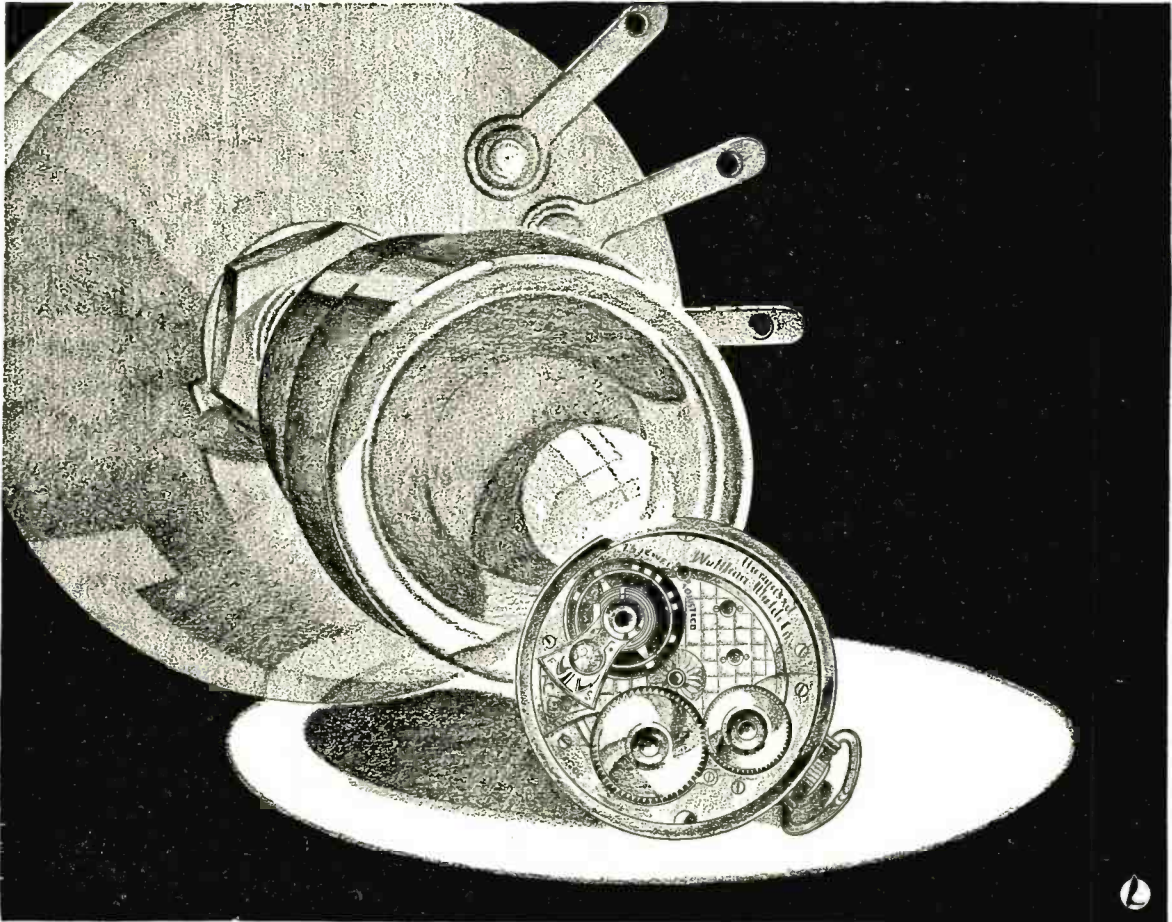

21 JEWEL DEPENDABILITY

Accuracy in construction makes for accuracy in performance. The watch-like precision so characteristic of the CENTRALAB Volume Control is reflected in its smooth, noiseless, ACCURATE performance.

Just as satisfactory service in a watch is the result of the perfection of its many parts . . . radio performance is no less dependent upon the accuracy of its component units.

That more than twenty million radio receivers have been CENTRALAB equipped is a splendid testimonial to the watch-like precision with which it is built.



The New CENTRALAB
Volume Control
with Off and On Switch

More convenient than when mounted separately. Saves space, saves assembly cost, saves in first cost. Engineers: send your volume control specifications for samples to Central Radio Laboratories at Milwaukee, Wis.



R. S. BURNAP

ROBERT S. BURNAP, commercial engineer, RCA Radiotron Company, Inc., Harrison, N. J., graduated from Massachusetts Institute of Technology, in 1916, with the B.S. degree in electrical engineering.

Since graduation Mr. Burnap has

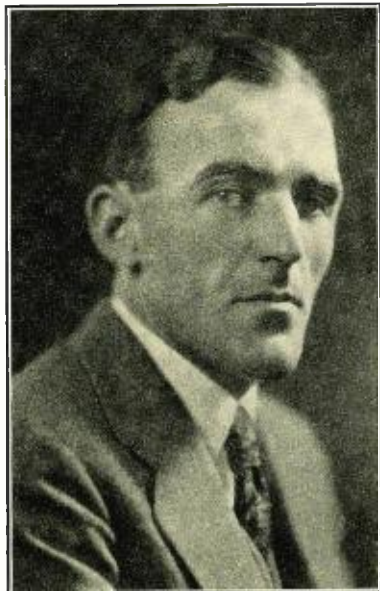

R. S. BURNAP
Commercial Engineer, RCA Radiotron Co., Inc.

been continuously identified with research and development of electric lamps and vacuum tubes. During the war he was in U. S. Signal Corps service at Camp Vail, N. J. He was for fourteen years connected with the Edison Lamp Works of the General Electric Company, a year ago becoming commercial engineer for RCA Radiotron Co., Inc.

Mr. Burnap is a Member of the A.I.E.E., and of the S.M.P.E. He is an Associate of the I.R.E. and of the I.E.S.

He has been granted patents covering various inventions, particularly the design of projection type lamps.

Mr. Burnap is a diligent student of the literature of radio and of photography. He possesses a fine collection of works on these subjects.

▲

DATES FOR NATIONAL RADIO WEEK SET

National Radio Week for 1931 has been definitely set as the week of September 21st to 27th, which coincides with the dates of the Radio World's Fair in New York. It will be recalled that last year thirty-five cities observed the event, thirty-two chain programs

were dedicated to radio, and over two hundred broadcasting stations carried announcements celebrating radio's 10th birthday. The executive offices of the N.F.R.A. have already started on plans for making National Radio Week a more elaborate event this year than ever before. Further details for the observance of the event will be given out at a later date.

▲

RADIO TALKIES NEARLY READY FOR THE HOME

WITHIN the next few weeks, television will likely pass from the purely engineering state to the nascent showmanship state. With the inauguration of the first radio talkies studio in New York City, artists and speakers will be *seen* as well as heard by the radio audience in homes provided with a television receiver in addition to the usual broadcast receiver. The programs will be of such varied and entertaining character as to provide fresh radio thrills to those who can *look in* as well as listen in.

Radio talkies, or combined sight and sound programs, are made possible by combining the television facilities of the Jenkins Television Station W2XCR, located on Fifth Avenue, New York,

with the sound broadcasting facilities of station WGBS located in Astoria, L. I. The television transmitter, with an output of 5,000 watts, operates on 2035 kilocycles or 147.5 meters, while the WGBS transmitter operates on 1180 kilocycles or 254 meters. The signals of the former may be tuned in by means of a special television receiver with radiovisor, for the pictorial component of the program. Tuning the broadcast receiver to 254 meters provides the synchronized sound component. The visual and aural combination is practically the same idea as the present-day talkies contrasted with the former silent pictures.

The radio talkies studio, in the same building as the television transmitter, is not unlike the usual broadcasting studio with draperies and other acoustic treatment. However, in addition to microphones, the performer faces a sweeping beam of light which scans or analyzes the image to be transmitted. The beam sweeps the subject in 60 parallel lines at the rate of 20 times or frames per second. The reflected light from the image is picked up by a battery of photoelectric or light-sensitive cells, sometimes referred to as electric eyes, which translate the varying amount of light into corresponding electrical terms amplified millions of times.

ESSENTIALS OF NATIONAL ELECTRIC CODE APPLIED TO RADIO

Antenna and Counterpoise

If of copper, not less than 14 gage. Splices or joints must be soldered, or an APPROVED splicing device may be used. If light socket antenna used this must be APPROVED. Possible contact, by swinging or sagging, with light or power wires must be avoided.

Lead-in

If copper, size not less than 14 gage. If copper-clad steel, size not less than 17 gage. Attachments must be such that contact with light or power wires is avoided. If lead-in strip is used this must be an APPROVED device. The lead-in conductor from building entrance to receiver must be rubber covered.

Lightning Arrester

Each lead-in conductor must be protected by an APPROVED lightning arrester, which on test will operate at 500 volts or less. If mounted outside building must be placed as near as possible to point of entrance. If inside, may be mounted at a point between entrance and receiver.

Arrester Ground Contact

Conductor from arrester to ground contact must be not smaller than No. 14 gage, if of copper. Conductance per unit length must be not less than that of the lead-in. Must run in as nearly a straight line as possible from arrester to ground. Ground may be to a water pipe (cold) where in service and connected to street mains. May be made to steel frame of building or to a galvanized pipe or rod driven into permanently damp earth. Protective grounding conductor if run inside building must be well secured in place and must not be closer than 2 inches to an electric light or power wire not in conduit, unless separated by a continuous, firmly fixed non-conductor, such as porcelain tubing or flexible tubing. An APPROVED ground clamp must be used where ground wire is attached to pipe or rod.

SHAKEPROOF

Every Twisted Tooth Forms a Separate Lock

THE tremendous holding power of the Shakeproof Lock Washer is due to its patented multiple locking design. Each twisted tooth acts individually and bites into both the nut and work surface—setting up a powerful resisting force that positively prevents any movement of the nut. Then, realize that this force is multiplied from ten to sixteen times—depending on the number of teeth in the washer—and you can understand why Shakeproof is so far superior to any other locking method.

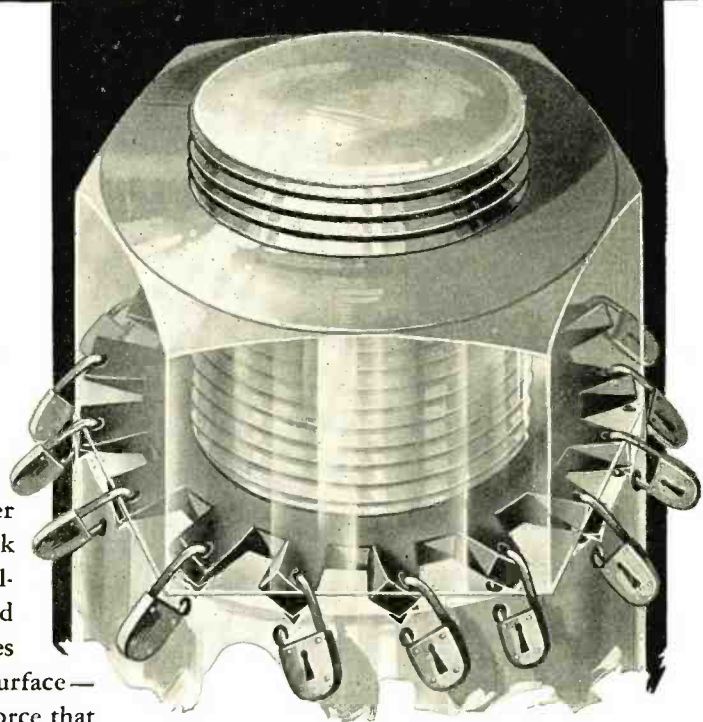

You can't save money by buying inferior lock washers. They are the greatest cause of poor performance, which means expensive service charges and dissatisfied customers. Give your product the benefit of Shakeproof protection—mail the coupon for trial samples, today!

U. S. Patents:
1,419,564
1,604,122
1,697,954
1,782,387
Other patents pending.
Foreign patents.

SHAKEPROOF Lock Washer Company

{Division of Illinois Tool Works}

2509 N. Keeler Avenue, Chicago, Ill.



Type 12. Internal For S. A. E. and Standard Machine Screws

Type 11. External For Standard Bolts and Nuts

Type 15. Countersunk For all Countersunk Screws

Type 20 Locking Terminals For Radio and Electrical Work

Shakeproof representatives are located in the following cities

- | | | | | | |
|---------------|--------------|---------------|--------------------------|---------------|-----------|
| New York City | Philadelphia | Boston | Pittsburgh | Schenectady | Cleveland |
| Detroit | Toledo | Cincinnati | Birmingham, Ala. | Dallas, Texas | Milwaukee |
| Los Angeles | Seattle | San Francisco | Toronto, Ontario, Canada | | |

COUPON

Gentlemen: We want to test your Shakeproof Lock Washers. Kindly send us samples as indicated.

Type..... Size.....
Type..... Size.....

Firm Name.....

Address.....

City..... State.....

By..... Title.....

Design notes on beat frequency oscillators

By GEORGE A. BRUESKE

For factory and service radio laboratories the beat frequency oscillator herein described will be found of real use.

THE beat frequency oscillator is to be found in many radio laboratories for the generation of audio-frequency or low r-f. voltages. It has particular advantages where a wide frequency band is to be covered rapidly with but one control. Also, the absence of large inductances or capacities in its construction, as well as the independence of the generated frequency on the output load, has done much to bring it in favor for many purposes. For those who have occasion to design such an oscillator the following design procedure may be found useful.

The typical beat frequency oscillator consists of two radio-frequency oscillators, a detector, and, usually, an amplifier to increase the output of the detector to a useful level. Fig. 1 represents such an oscillator. The two frequencies generated by the radio-frequency oscillators are caused to heterodyne each other in the grid circuit of the detector tube, the resulting beat note being the frequency desired in the output. The beat frequency will be the frequency difference between these two radio frequencies. The frequency of one of the oscillators is made variable to produce the particular frequency difference required with the other oscillator. It is the design of this variable oscillator which concerns us here.

The frequency of this r-f. oscillator will, of course, be determined by the inductance and the capacity in the tuned circuit, shown in Fig. 2. This consists of a fixed inductance L, a variable capacity C₂, and a fixed capacity C₁, which also includes stray capacities such as that of the associated tube, the

minimum capacity of C₂ wiring capacity, etc. Changing the capacity of the variable condenser from zero to maximum will shift the frequency of the oscillator over its entire operating range, and, hence, the output beat frequency will shift accordingly. It is usual to make the frequency of the variable oscillator equal to that of the fixed oscillator at one or the other extremes of its frequency range. The output or beat frequency will then be zero.

It is necessary before proceeding to decide on the frequency range of the r-f. oscillators, and to choose the variable capacity C₂. The value of L and C₁ remains to be computed.

With C₂ at zero (when condenser plates are all out) the frequency of the tuned circuit in Fig. 2 will be determined by L and C₁ alone. The oscillator frequency will then be at its highest value, which may be computed by the following:

$$f_1 = \frac{K}{\sqrt{L C_1}}$$

in which K is a constant, the value of which depends on the units in which L and C and f are expressed.

By squaring both sides of the equation,

$$f_1^2 = \frac{K^2}{L C_1} \tag{1}$$

and by transposing:

$$L C_1 = \frac{K^2}{f_1^2} = A \tag{2}$$

However, with C₂ at its maximum value, the lowest frequency, f₂ will be generated. The total capacity in the tuned circuit will now be C₁ + C₂. As

the inductance will remain unchanged as in the equation (1):

$$f_2 = \frac{K}{\sqrt{L (C_1 + C_2)}}$$

By squaring both sides of the equation as before, and by multiplying C₁ + C₂ by L:

$$f_2^2 = \frac{K^2}{L C_1 + L C_2}$$

and by transposing:

$$L C_1 + L C_2 = \frac{K^2}{f_2^2} = B \tag{3}$$

By comparing equations (2) and (3), it is apparent that the difference between them is that the latter has the term L C₂ while the first has not. So if equation (2) is subtracted from equation (3) the remainder will be the quantity L C₂. By carrying out this subtraction;

$$(L C_1 + L C_2) - (L C_1) = \left(\frac{K^2}{f_2^2}\right) - \left(\frac{K^2}{f_1^2}\right) = B - A$$

or simply;

$$L C_2 = B - A$$

Then dividing both sides of the equation by C₂ the inductance L can be determined.

$$L = \frac{B - A}{C_2} \tag{4}$$

where the values of A and B are determined from the equations (2) and (3).

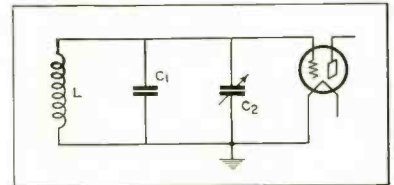

Fig. 2. Tuned circuit of oscillator.

C₁ can now be readily found by transposing equation (1) to the form

$$C_1 = \frac{K^2}{f_1^2 L} \tag{5}$$

and by using the value for L determined by equation (4).

For a numerical example, suppose it is required to design a beat frequency oscillator to cover the band of zero to 10,000 cycles. The frequency band chosen for the variable oscillator is to run from 100 to 110 kilocycles. The condenser for C₂ available is of 250 μμf capacity. The value of K will be 159,140 where f is given in kilocycles, L in microhenries, and C in micro-microfarads. Substituting 110 kc and the value of K in equation (2),

$$A = 2,090,000$$

and similarly, as the value of f₂ is 100 kc; from equation (3),

$$B = 2,530,000$$

Then, from equation (4):

$$L \mu h = \frac{2,530,000 - 2,090,000}{250} = 1,760$$

Also, from equation (5):

$$C \mu \mu f = \frac{159,140^2}{110^2 \times 1,760} = 1,220$$

If it is desired to use the same size

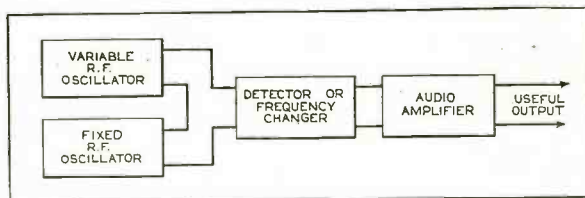
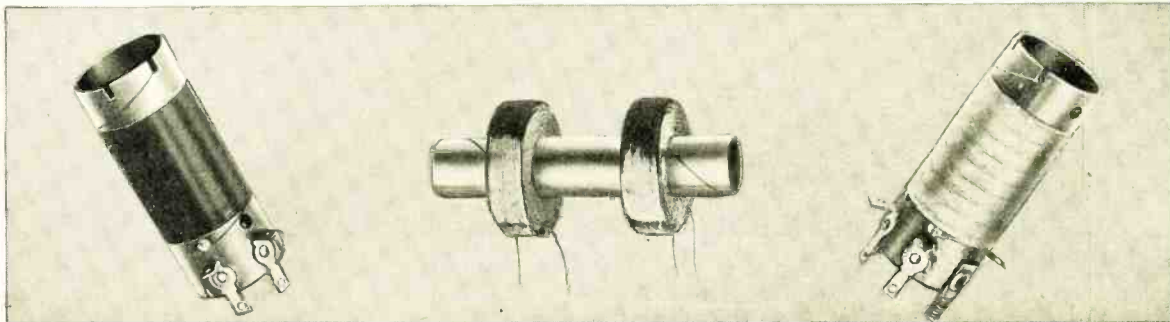
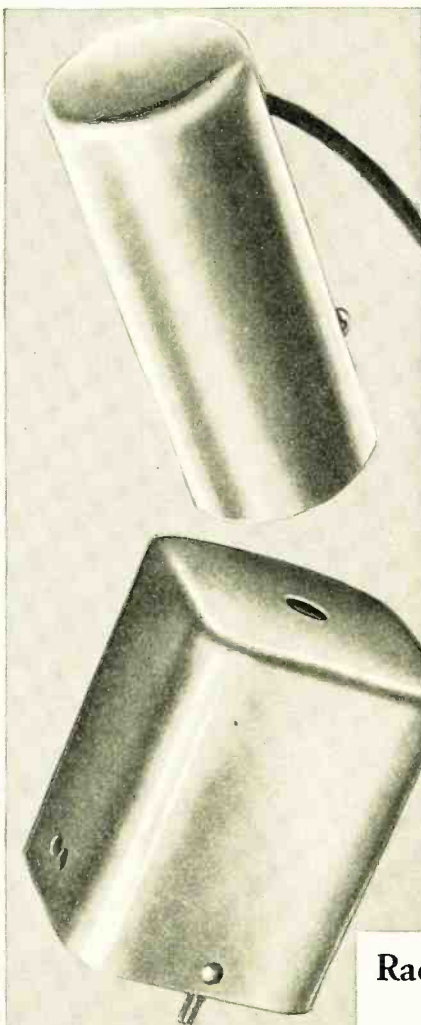

Fig. 1. Beat frequency oscillator schematic.



COILS—and a complete high grade engineering service



Your entire set developed up to the coils—then comes that problem—but don't worry about it—put it up to us—we'll give you the right coil solution. That's our specialty.

Our laboratory, under direct charge of Mr. Wm. P. Lear, well known throughout the radio engineering field, has successfully designed coils for every type of radio.

In addition to designing the right coil, we make, at your request, suggestions for improvements in your set. In return for your coil business we will assist in designing a set for you or in re-designing your old set.

We originated the first miniature type of bank-wound inductance. We also did the original thinking and developing on Litz wire, as applied to modern radio.

Our laboratory has a fund of valuable radio information. Don't hesitate to bring your coil and set problem to us.



Radio Coil and Wire Corp.
 847 West Harrison Street
 CHICAGO, ILLINOIS
 For engineering information write
 LEAR, WUERFEL, Inc.
 Exclusive Sales Engineers
 847 West Harrison Street
 Chicago, Illinois

of coil for the fixed oscillator, then this oscillator is also designed, L being 1,760, μ h and the total tuning capacity being either 1,220 or 1,470 μ f, depending upon which of the two extreme frequencies of the variable oscillator it is desired to match for zero beat.

It is good practice to make both oscillators as near alike as possible. Any changes in A or B voltages or other circuit conditions which would tend to change the frequency, will affect both oscillators alike and tend to maintain the beat note unaltered.

The frequencies chosen for the radio oscillators should be sufficiently high to permit these frequencies to be readily kept out of the audio frequency amplifiers. Using the customary plate circuit by-pass condenser and with possibly a radio-frequency choke in the plate lead of the detector tube is usually all that is necessary for filtering. While a stage or two of audio frequency generally stops all r-f. in the output, r-f. often overloads the grid on the first stage tube, and is a well known cause of audio-frequency distortion in the amplifier, especially if it is resistance coupled with conventional grid condenser and leak.

"Pulling Together" Obviated

Contrary to the above, the radio frequencies should be as low as possible to prevent the two oscillators from "pulling" together at low beat frequencies. It is common knowledge that as the frequencies of the two oscillators, which are more or less coupled to one another, approach the same value; one of the oscillators will suddenly jump into synchronism with the other, the frequency being no longer under exact control of its own tuned circuit. The frequency difference at which this jump occurs will depend on the degree of coupling and on the relative frequencies—the lower the frequency, the smaller the difference in frequency may be before the shift occurs.

A compromise between the two foregoing conditions is necessary in a practical design, and a choice of frequency

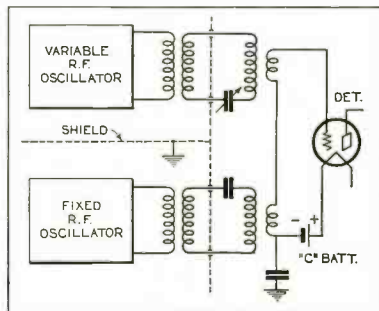

Fig. 4. Showing series circuit between oscillator and detector.

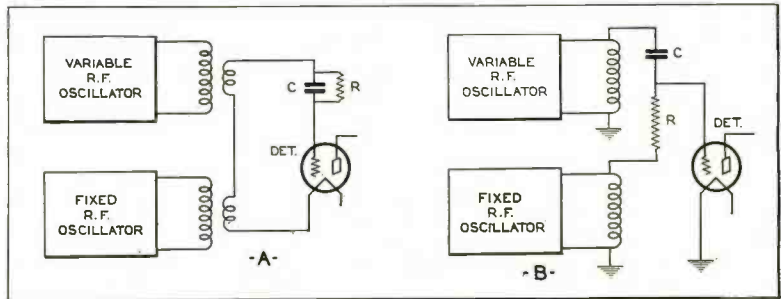

Fig. 3. Methods of coupling for detector feed.

will depend on what beat frequencies are desired, and how close zero beat is to be approached. For an oscillator to generate frequencies between about 30 and 10,000 cycles per second, frequencies for the r-f. oscillators may be between 50 and 150 kc. and give satisfactory performance.

One way to eliminate "pulling" at the expense of simplicity, is to electrically isolate each oscillator by shielding and by providing a screen-grid radio frequency "buffer" stage between each oscillator and the detector. However, if trouble is experienced in a conventional style oscillator, the coupling to the detector can usually be sufficiently reduced to generate as low a beat frequency as is required for the majority of uses, and still give sufficient output.

Stable Frequency Desirable

The oscillators should be designed to generate as stable a frequency as possible, since a small percentage change in the radio frequency of either oscillator produces a much larger change in the beat frequency. This is another reason for the use of relatively low frequencies. Because of the large capacities required in the tuned circuit of low radio-frequency oscillators, tube and other stray capacities become of minor importance. A high ratio of capacity to inductance in the tuned circuit should be employed for the same reason.

Various styles of coupling may be used to feed the detector with the voltages of the two r-f. oscillators. The arrangement at Fig. 3-A is the common method. The two detector coils are of but a small number of turns so that the mutual coupling between the two oscillators shall be small. At Fig. 3-B, is a unique arrangement that was used on a Western Electric superheterodyne some years ago. The author has used this to good advantage on beat frequency oscillators, its simplicity being its chief merit. Here the r-f. in the grid leak permits the discharge of the grid condenser on but one half of the cycle.

Where the output must be free from harmonics, one should take various pre-

cautions to produce a pure waveform. The oscillator tubes should not be overloaded with high plate voltage, as harmonics present in the radio frequencies will produce corresponding harmonics in the output.

Harmonics may further be reduced by filtering the outputs of each r-f. oscillator before they are fed to the detector. A simple series circuit, as shown in Fig. 4, inserted between the oscillator and detector will tend to suppress the harmonics and allow only the fundamental to pass. The tuned filter may also be made a part of the screen-grid "buffer" stage referred to. It is, of course, desirable to gang the oscillator and filter condensers.

The ganged circuits should be carefully matched in frequency at all points of the dial. Lack of alignment will cause erratic variation of the output voltage. Conversely, lack of uniformity of the output voltage due to other causes can be compensated for by detuning the filter circuit slightly at the proper points on the dial.

For ordinary uses to which a beat frequency oscillator may be put, the elaborations listed above would hardly be necessary nor economical. A simple arrangement as outlined Fig. 1, unshielded, will meet 90 per cent of the needs in a factory or service laboratory, and certainly is well worth the time expended on its construction.



BOOK REVIEW

LEFAX RADIO RECEIVING TUBE DATA. Published by LEFAX, (Inc.), 9th & Sansom Sts., Philadelphia, Pa., 32 pages, with durable cover. \$1.00 complete.

What type radio tube to use—how much its volume should be—and similar quick-facts are found in this new 32-page, loose-leaf, pocket-size, booklet on radio receiving tubes.

Lefax Radio Receiving Tube Data presents over eighty graphs, giving static and dynamic characteristics of all types of vacuum receiving tubes. It also has an interesting discussion of the new power pentode and variable-mu tubes, as well as tabulated data on seventeen additional special type tubes.

More Accurate Direct Measurement of Mutual Conductance*



An instrument that makes more sensitive and more accurate direct measurement of vacuum tube mutual conductance has been developed by the Jewell laboratories.

This equipment is adaptable to wide application in either laboratory or production testing, the indicating instrument being a high torque rugged direct current instrument of standard design. In conjunction with Jewell Instrument Relays, rejection or acceptance of tubes may be done by automatic machinery.

Previous methods of direct measurement of mutual conductance usually gave results which were of necessity modified by the relatively heavy plate circuit load in the tube under test. The Jewell Synchronous Commutator Method increases the plate impedance less than 1%, giving a true reading of this most important tube characteristic under any and all conditions, and regardless of the μ of the tube.

Normal operating potentials are applied to the tube under test, assuring the utmost accuracy for the measurements. Variable- μ tubes may be tested at a series of control grid potentials over their entire working range.

An engineering data sheet completely describing the "Synchronous Commutator" method and Jewell equipment for applying it to your needs, has been prepared. Write for it today.

Visit Booth 6 at the I.R.E. Convention in the Hotel Sherman, and Booth B-74 in the Stevens Ballroom at the R.M.A. Show. The complete Jewell line of electrical measuring instruments will be on display.

31 YEARS MAKING GOOD INSTRUMENTS
JEWELL

Jewell Electrical Instrument Co.
1642-P Walnut St., Chicago, Ill.

Please send me engineering bulletin
No. 10.

Name.....

Address.....

IRE Convention At Chicago

THE Sixth Annual Convention of the Institute of Radio Engineers will be held in Chicago, June 3-6, inclusive. Although the Institute had been holding monthly meetings in New York and in several section headquarters cities since the year 1912, it was not until 1925 that it was decided to hold a general convention. The first convention was held in New York, January 18-19, 1926. Since that time the annual and regional conventions held have been notable successes.

The program for the Chicago Convention this year follows:

Wednesday, June 3

Registration

Thursday, June 4

Registration and inspection of exhibits. Opening session. Addresses of welcome by Ray H. Manson, president of the Institute, and Byron B. Minnium, chairman of the Chicago section and chairman of the convention committee.

Technical Session. "The 'Spokesman' for the Radio Engineer," by Captain S. C. Hooper, U. S. Navy.

"Thyratron," by J. C. Warner, General Electric Company.

"Music in Colors," by E. B. Patterson, RCA Radiotron.

"Amplitude, Phase and Frequency Modulation," by Hans Roder, General Electric Company.

Official luncheon. Address by Colonel Ishan Randolph, president of the Association of Commerce of Chicago.

Inspection of exhibits.

Trip No. 1. To Grigsby-Grunow Company and Stewart-Warner Corporation.

Technical Session. "The Saxonburg Radio Station," by Frank Conrad and R. L. Davis, Westinghouse Electric and Manufacturing Company.

"Field Strength Measurements and Broadcast Coverage," by C. M. Jansky, Jr., Jansky and Bailey.

"Developments in Common Frequency Broadcasting," by G. D. Gillett, Bell Telephone Laboratories.

"New Method of Frequency Control Employing a Long Line," by C. W. Hansell, J. L. Finch and Mr. Conklin, RCA Communications.

"Some Observations of the Behavior of Earth Currents and Their Correlation with Magnetic Disturbances and Radio Transmission," by Isabel S. Benis, American Telephone and Telegraph Company.

Trip No. 2. Shopping trip for ladies. Inspection of exhibits.

Trip No. 3. Ladies' tea and fashion promenade.

Trip No. 4. American Telephone and Telegraph Company and Illinois Bell Telephone Company.

Trip No. 5. National Broadcasting Company studios.

Lecture on "Modern Conception of the Electron," by Professor A. H. Compton of the University of Chicago.

Theatre party for ladies.

Inspection of Ryerson Laboratory of the University of Chicago.

Annual meeting of the Committee on Sections at the University of Chicago.

Friday, June 5

Inspection of exhibits.

Technical Session. "Technique of Loudspeaker Sound Measurements," by Stuart Ballantine, Boonton Research Corporation.

"Acoustic Problems of Sound Picture Engineering," by W. A. MacNair, Bell Telephone Laboratories.

"Rochelle Salt Crystals as Electrical Reproducers and Microphones," by C. B. Sawyer, Brush Laboratories.

"High Audio Output from Relatively Small Tubes," by L. E. Barton, RCA Radiotron.

Trip No. 6. Ladies' sight-seeing tour. Inspection of exhibits.

Trip No. 7. Hawthorne Works of the Western Electric Company.

Trip No. 8. Luncheon and bridge for ladies.

Inspection of exhibits.

Banquet, entertainment and dancing.

Saturday, June 6

Trip No. 9. Ladies' trip to Art Institute, Field Museum, or Aquarium. Technical Session. "Constant Frequency Oscillators," by F. B. Llewellyn, Bell Telephone Laboratories.

"Electron Tubes as High Frequency Alternators," by E. D. McArthur and E. E. Spitzer, General Electric Company.

"Development of Directive Transmitting Antennas for Short Wave Transmission," by P. S. Carter, C. W. Hansell and N. Lindenblad, RCA Communications.

"Development of Short Wave Directive Antennas," by E. Bruce and H. T. Friis, Bell Telephone Laboratories.

Inspection of exhibits.

Trip No. 10. Riverbank Laboratories (ladies invited).



An Irish correspondent of 2XAF, who is interested in the sponsored programs of the United States reported that he tuned out an "Uncle Abe and David" program in disgust recently because, as he thought, it was sponsored by a tombstone company. A severe attack of influenza had left him too weak to appreciate selling arguments for tombstones. Uncle Abe and David fans will recall David's strenuous campaign to sell six tombstones at reduced prices to get one for nothing.



A Welshman of perfect candor writing W2XAF opened his letter with the arresting statement: "I'm not really keen on you Yankees as a nation but must admit your wireless programs are the goods." After expressing a decided preference for the commercially sponsored program over the offerings of the British Broadcasting Corporation he added "And the irony of it is that I must pay ten shillings to my government to hear Yankee programs." Owners of radio receivers in England must pay an annual tax of ten shillings.

WELDED LEADS

eliminate the possibility of variation of resistance values in all temperatures



Open circuits are avoided when you use ERIE RESISTORS because of the "one piece" construction which totally eliminates the possibility of variation in resistance values—in all temperatures.

Since neither heat nor cold affects ERIE RESISTORS they consistently do their part in delivering perfect performance to users of your products. ERIE RESISTORS are favorably known among radio engineers because of their justly earned reputation for passing every test.

We will gladly send you samples, prices and any desired information.

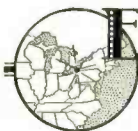

RIE RESISTORS

Erie Resistor Corporation, Erie, Pa.
In the Center of the Radio Industry

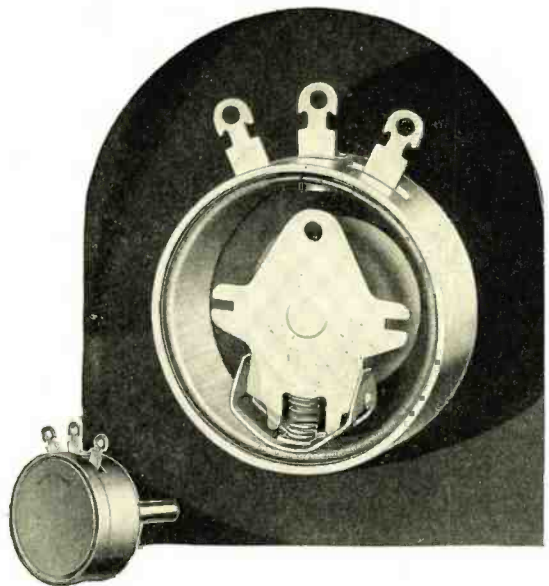

Here is an achievement!

The perfection by our engineers of our new No. 20 Series Wire-Wound Volume Controls to a degree that practically eliminates all noise in operation, is a distinct Frost-Radio achievement. Many months of research and ceaseless endeavor are back of this new type noiseless unit. Its construction embodies a new principle of design, the use of the finest materials available, and an extremely high standard of accuracy in manufacture, which had the courage to reject previous precision attainments and recognize that accuracy within limits of tenths of thousandths of an inch was not only possible, but well worthy of accomplishment

... Unquestionably the year's highest achievement in the volume control field!



CHICAGO TELEPHONE SUPPLY CO.
HERBERT H. FROST, Inc., Sales Division
GENERAL OFFICES AND PLANT
ELKHART, INDIANA

FROST - RADIO

NEWS OF THE INDUSTRY

SELF-TAPPING SCREWS

A booklet with the above title has been issued by the Parker-Kalon Corporation, 100 Varick Street, New York.

But little information of the kind found in this booklet has been available. Although it features the security of metallic fastenings made with Parker-Kalon hardened self-tapping screws, it also contains considerable unbiased information on the holding power of other fastening devices; and should be helpful and interesting to any design or production man who is concerned with metal assembly.

The booklet will be sent free of cost to any design or production man who requests it and gives the name of his company and his title.

S. M. KINTNER ELECTED WESTINGHOUSE VICE-PRESIDENT

S. M. Kintner, who has been assistant vice-president of the Westinghouse Electric and Manufacturing Company, was elected vice-president in charge of engineering for that company at a recent meeting of the board of directors. He succeeds W. S. Rugg, who has been elected vice-president in charge of sales.

In 1894 Dr. Kintner was graduated from Purdue University, where he studied electrical engineering. After spending a year on telephone construction and operation, he accepted the position as assistant to Professor Fessenden at the Western University of Pennsylvania, (now the University of Pittsburgh) which he held for two and a half years. He then was made assistant professor of mathematics and later professor of engineering, succeeding Professor Fessenden. While at the Western University of Pennsylvania, he worked with Fessenden on many investigations on Hertz waves, X-rays, and other phenomena coming into prominence at that time. He remained professor of engineering for three years, and resigned in the summer of 1903 to accept a position in the research department of



S. M. KINTNER
Vice-President Westinghouse Electric
& Mfg. Company

the Westinghouse Electric and Manufacturing Company.

After four years of study in connection with high tension phenomena, a-c. electrolysis, telephone interference, and motor flashing troubles, he was made design engineer in charge of a-c. railway motor design.

In 1911 he resigned from the Westinghouse Company to accept the position of general manager of the National Signalling Company, and became engaged in developing the radio inventions of Fessenden. Later he became vice-president and finally president of that organization. During the war the company with which Dr. Kintner was associated made a large amount of radio apparatus for the Navy and Signal Corps.

Following the war, he negotiated a sale to the Westinghouse Company of the patent rights of his company. After spending approximately two years with the Westinghouse Company in radio development, he was appointed manager of the research department. On April 16, 1930, he was elected assistant vice-president in charge of the engineering activities of the company.

UNITED SCIENTIFIC LABS. IN LARGER QUARTERS

The United Scientific Laboratories, manufacturers of Type SG shielded condensers, Type BT armored condensers and Type CC compensating condensers announce the removal of their plant to 510-18 Sixth Avenue, New York City. The United Scientific Laboratories will occupy 30,000 square feet of space at their new address.

LACQUER MATERIALS USED BY RADIO MANUFACTURERS

The proper selection of finishing materials for radio parts is important and is now given more attention than ever before. Lower costs of manufacture play a large part in meeting the competition of today. With these two factors in mind, the Maas & Waldstein Company, 438 Riverside Ave., Newark, N. J., have developed over a period of years a number of lacquers and cements specially designed for radio manufacturers.

In instances where the base is cadmium plated, stains and finger marks are commonly found unless protected with lacquer. They may be sprayed or dipped. The former has the advantage of confining the spray coat of cadmium lacquer to the parts needing protection but leaving any contact surfaces bare. Dipping into water dip lacquer finds favor on account of its low cost of handling as parts may be dipped directly from the plating baths, while wet, into the lacquer and then air dried in a few minutes ready to be handled in the assembly line. Soldering may be done through the water dip lacquer coating without difficulty. Where an opaque decorative finish is desired, mahogany prismaac gives a crystal structure finish which obliterates drawing marks, spot welds or other metal defects in one spray coat.

The smaller metal stampings are commonly finished in the same manner as the chassis base. In some instances a clear lacquer or a bronze lacquer containing bronze powder is used.

Use of the proper lacquer and cement materials on the vital parts of the speaker are of importance. If the cone paper is to be lacquered to prevent variations in tone, a minimum of weight coupled with maxi-

mum waterproofing qualities and proper stiffness must be imparted to the paper.

Waterproof paper lacquer is best applied by spraying.

The paper, leather or cardboard joints are firmly held together by means of a quick setting cement. This is accomplished either at room temperature by means of cold clamps or in hot presses to obtain a faster operation. The cemented joint must not be affected by high humidity or result in deterioration from any other cause. Many cementing operations now done by hand may be accomplished by comparatively simple machines at considerable saving in cost.

Cementing of metal or bakelite parts is often found difficult but may be done through selection of a cement designed for the purpose.

The voice coil wires require a cement that will add as little weight as possible and yet bind the wires permanently together and to the core so as to leave a clean appearance.

The metal speaker frame, if cadmium plated, may be finished in water dip lacquer or else in an opaque dipping lacquer enamel.

Like the voice coils, r-f. coils must have protection against corrosion and moisture. An insulating lacquer, either clear or black, of high dielectric strength is applied by dipping.

For wood cabinets, after staining and filling the wood, a clear sanding sealer followed by a coat of flat wood lacquer is generally used. Both materials require high solids so as to obtain the desired depth of finish and covering, together with proper clarity of film and durability.

KAHLE SELLS LAMPS AND TUBE MACHINERY

The Kahle Engineering Company announces that it has opened offices and a warehouse at 548-39th St., Union City, N. J., to do business in machinery equipment, and raw materials used in the manufacture of radio tubes, incandescent lamps, neon lamps, and other vacuum products.

L. C. Kahle, the head of the concern, is a pioneer engineer in the industry. Mr. Kahle has occupied important engineering positions with the Westinghouse Lamp Company, Independent Lamp and Wire Company, the Crystolite Mfg. Company, David Grimes, Inc., Pilot Radio Company, and others.

He has designed and built many of the machines which are in use today for the manufacture of lamps and tubes.

Associated with Mr. Kahle is Jac. Hohenstein, formerly president of the Magnatron Corporation, and later director of the National Union Radio Corporation, which acquired the former concern.

Mr. Hohenstein was formerly a lamp manufacturer, and is a pioneer in the radio tube industry.

The Kahle Engineering Company is engaged in the business of buying and selling machinery, jigs, tools, dies, and other accessories of lamp and tube manufacture, as well as raw materials.

REPLACEMENT RESISTORS AND VOLUME CONTROLS

Electrad, Inc., 175 Varick Street, New York, has issued a new reference card covering the Electrad line of replacement volume controls and resistors. The resistor requirements of 343 different radio receivers are shown. Copies of this valuable folder may be procured upon request.

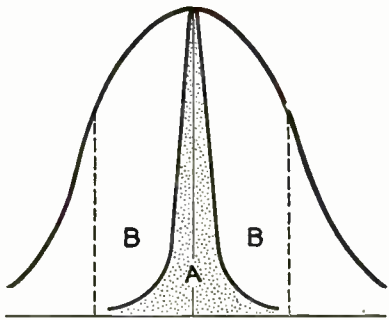

Inner curve shows Stenode's selectivity, outer curve that of ordinary receiver. Lines BB are 5 k. c. distant from Line A. All background noise, included in the light portion between A and BB is eliminated by the Stenode.

STENODE TUBES

Until the American Tube Manufacturers licensed by the Stenode Corporation of America are in sufficient production, we can supply the rapidly growing demand of laboratories and serious investigators for:

QUARTZ CRYSTALS

*Suitably Mounted in Tube Form
To Fit Standard Tube Sockets*

These crystals are all approved by our own laboratory after actual tests in a standard Stenode developed under the patents of Dr. James A. Robinson, M.B.E., D.Sc., Ph.D., M.I.E.E., F. Inst. P., and former Chief of Wireless Research, British Royal Air Force, by the engineers of the Stenode Corporation of America.

All crystals are ground to respond to a frequency of 175 kilocycles, which is the frequency accepted as standard in all modern superheterodynes, and are mounted in vacuum tube form.

STENODE TUBES (Standard U X Socket Base) **PRICE \$15.00**

"If it isn't a STENODE it isn't a modern receiver."

Stenode Corp. of America
(Formerly American Radiostat Corp.)

Hempstead Gardens, Long Island, N. Y.

STENODE CORP. OF AMERICA
Hempstead Gardens, Long Island, N. Y.
Enclosed find Personal Check, P. O. or Express Money Order
for which please forward me.....Stenode Tubes.
(state number)

NAME.....
STREET.....
CITY.....STATE.....



**ARCTURUS
PZ
PENTODE**

SENSITIVE...

*4 times the sensitivity
of a '45 Power Tube*

Because of its high "power sensitivity" the Arcturus PZ Pentode is almost 4 times as sensitive as the '45 power tube—a feature of decided importance when considering output, detector overload and plate supply arrangements. Greater volume, increased efficiency, and compactness of set design are the natural results.



**ARCTURUS
551
VARIABLE-MU**

DISTORTION IS NEGLIGIBLE...

*even at 20 times the
voltage of a '24 tube*

The input limit for the Arcturus 551 is 4 to 10 volts as compared to a typical '24 tube which is about 0.2 to 0.4 volts. The 551 tube operates without distortion at about 20 times the voltage permissible with the '24 tube.

This and other features of the Arcturus 551 eliminate the need for double pre-selectors, dual volume controls, and "local-long distance" switches. Maximum cross-talk is divided by 500; receiver hiss is reduced. Circuits using this new tube are simplified as well as more efficient.

*Send for Technical Bulletins giving complete performance data on the
Arcturus Type PZ Pentode and the Arcturus 551 Variable-Mu Tube.*

ARCTURUS RADIO TUBE CO., NEWARK, N. J.

ARCTURUS

The TUBE with the LIFE-LIKE TONE

NICKEL TUBING

The scientific care used in making Sumnermill seamless nickel tubing is carried through until it reaches the consignee. It is packed in a sturdy box carefully made to insure the contents against all shocks in transport. It assures perfect condition of the tubing when it reaches its destination. Samples of tubing may be procured by production managers and engineers.

PIERCE AIRO IN LARGER QUARTERS

With a good year behind them and optimistic as to the future, David Wald, president of Pierce Airo, Inc., announces the removal of the Pierce Airo factory to 510-518 Sixth Ave., New York City, where they will be in a position to double their former capacity.

The new Pierce-Airo pentode radio trio consists of a pentode superheterodyne, a pentode super-tuned radio frequency for alternating current and a pentode super-tuned radio frequency for direct current.

Any of these units can be had in cabinet or chassis form, so that the Pierce Airo line provides a radio for every purpose.

The features of the new DeWald sets are pentode tubes, full vision dial, tone control, four screen grids, screen grid detection, phonograph pick-up jack, humless filter circuit, high intermediate-frequency gain, antenna adjuster, compactness and new electrodynamic speaker which gives smooth, rich and mellow tone.

SOCKETS

The Central Radio Corporation, 156 Roosevelt Avenue, Beloit, Wis., has issued a booklet giving mechanical information about CRC sockets. Copies will be sent upon request.

METALLIZED RESISTORS

The International Resistance Corporation, 2006 Chestnut Street, Philadelphia, Pa., announce a new booklet describing that corporation's 1931 line of metallized resistors. Copies may be had upon request.

RADIO EXHIBIT IN WASHINGTON

Establishment of a permanent radio equipment exhibit in the nation's capital has practically been assured. Negotiations are now being concluded with several of the leading manufacturers of radio transmission and sound reproducing equipment, for large sections of space in the exhibition hall, located in the National Press Building, according to Carl H. Butman, former secretary of the Federal Radio Commission and now chairman of the Board of Managers of the National Radio Equipment Exhibitors.

"The great interest being shown by manufacturers in this project definitely marks the recognition of Washington as the country's leading market place for their products. These makers of radio and sound equipment recognize that Washington is the focal point of contact of users of the ether channels. In selecting the National Press Building as a location for a permanent exhibit, advantage has been taken of the fact that it houses the Federal Radio Commission and many other prominent radio organizations. As a result of the frequency with which radio users visit this building, it has become the national radio headquarters."

The exhibit provides a desirable gathering and meeting place. It will be decorated in a modernistic trend and provision is made for ample lounging space, writing desks, information service and many other facilities designed to attract to it those who are interested in radio.

CABLE EXECUTIVE OFFICES MOVE

In order to allow increased facilities for production at their plant located at 84-90 N. 9th Street, Brooklyn, N. Y., the Cable Radio Tube Company, have removed their executive offices to 230-242 N. Main St., Brooklyn, N. Y.

PARTS FOR TUBES

So many new tubes are being brought out that Goat Radio Tube Parts, Inc., Brooklyn, N. Y., are constantly extending the variety of parts furnished to tube manufacturers. Just now there have been completed all the facilities for the quantity manufacture of additional items for the 233 and 238 tubes recently announced and which are, as our readers know, past the experimental stage in a number of tube plants.

Edward F. Staver, secretary of the company, says the rapid tube development of the past few weeks has overtaxed the engineering departments of many tube manufacturers and that his company is succeeding in easing the strain by supplying a continually increasing range of parts, formed with the utmost accuracy, ready for the assemblers.

MORE USES FOR METERS

To those interested in multiplying the usefulness of their electric meters, a chart, prepared by the engineering staff of International Resistance Company, is of practical value. This chart indicates how one may change a voltmeter into a multi-range voltmeter; a milliammeter into a d-c. voltmeter; a milliammeter into a high range reading milliammeter.

Since accuracy is the sole gauge of the worth of any electrical measuring apparatus, it is necessary to employ precision wire-wound resistors of the proper resistance values. Precision wire-wound resistors are now obtainable as regular equipment, with an accuracy of better than 1 per cent., or greater precision than the average small measuring instrument which is rated to within 2 per cent. accuracy.

CUSHION FEET FOR CABINET AND FURNITURE

The Standard Cushion Company, Bridgeport, Conn., is marketing a novel cushion corner support which has an adjustable feature. These new shock absorbing feet have obvious uses in the radio industry.

SIGNAL CORPS UTILIZES NEW CARDWELL FREQUENCY METERS

The Allen D. Cardwell Mfg. Corp., 81 Prospect Street, Brooklyn, N. Y., has recently been awarded a large contract to supply the Signal Corps of the U. S. Army with the new type BC-153 frequency meters.

These meters have a range of from 75 to 1500 kc. and are especially designed to conform to the high standards demanded by Army engineers. A special buzzer, emitting a note of high pitch, serves as a convenient source of damped oscillations. The buzzer windings are shunted by a resistor to prevent sparking when the circuit is broken. As a result, the buzzer gives a clear, steady musical tone. Small dry cells provide the current required to actuate the buzzer and a toggle switch in series in this circuit, is used to turn the buzzer "on" or "off."

When the contact is opened through the action of the buzzer, the energy due to the current in the inductance coil is transferred to the variable condenser giving it a charge. The condenser then discharges, setting up a train of oscillations in the circuit consisting of coil, condenser (and thermo-galvanometer). Naturally, the frequency of these oscillations depends upon the constants of the circuit. A three-way switch permits one, two or three coils to be used, as desired.

The condenser dial is divided into three sections corresponding to the three different

inductances available. This makes it easy to take close readings. A Weston thermogalvanometer is employed in this instrument. This has an accuracy within two scale divisions. Through the use of the three-way switch, the single variable condenser can be used to cover the entire range from 75 to 1500 kc. By removing a metal jumper between two binding posts on the panel, external coils of varying values may be connected in the circuit in order to extend the range of the instrument still further.

The Cardwell frequency meter is accurately calibrated and because of the high quality of its components, it can always be depended upon to give correct readings. All the working parts are contained within a compact, portable hardwood carrying case. The circuit diagram is pasted within the cover and switches, meter, dial, condenser control, etc., are conveniently available on the bakelite panel. Several U. S. Letters patents have been granted on the Cardwell frequency meter. This instrument is available, not only to the signal corps, but also to radio engineers and experimenters and for general laboratory use.

TELEVISION UNIT

The Shortwave & Television Corporation of Boston, Mass., manufacturers of the Baird shortwave receiver and television unit, have established a metropolitan and New Jersey sales office at 15 Lighthouse Street, New York, in charge of Arthur Roche and J. E. Nestead.

INSULATION MATERIAL FOR CONDENSERS AND COILS

Radio set manufacturers and others will be interested in a specially developed insulation known as X1B and X2B furnished in sheets, rods, tubes and various fabrications. Both grades have been developed particularly for the exacting insulating requirements and physical characteristics necessary for use in radio sets and radio parts.

Many leading manufacturers have approved and are at present making use of one or both of these grades. Careful tests show that these grades increase the selectivity of radio sets as much as 20 per cent when used as insulation on variable condensers, and similar improvement is noted by adapting these special grades of insulation at other vital points. For samples and complete information write the manufacturer, American Hard Rubber Company, 11 Mercer St., New York City.

JENSEN PERMANENT MAGNET SPEAKER

A permanent magnet speaker known as Jensen model PM-1, and the first of a new line of dynamic speakers designated as model J-1 were shown and demonstrated at the RMA Show, Chicago. They are made by the Jensen Radio Mfg. Co., Chicago. Copies of bulletin will be sent upon request.

RESISTORS FOR TELEVISION

The engineers of the International Resistance Company, Philadelphia, Penna., have been preparing from the standpoint of resistors for forthcoming television.

Special types of resistors are required, and the demands made upon resistors are in some cases more severe than in the conventional radio receivers because of the wide-spread use of resistance coupling in the amplifier portion of the television short wave receiver.

The International Resistance Company's engineering department is keeping as closely abreast of this interesting subject as is possible, and is cooperating with manufacturers who have special problems in this connection. They will be happy to assist in any way that they can in problems wherein resistors are involved.

NEW TUBES NEW CIRCUITS NEW VOLUME CONTROLS

Clarostat is ready with a special model wire wound control to exactly suit the new specifications.

Isolated rotor—all exposed metal parts out of electrical circuit.

Quiet, gradual control.

Long life windings.

Dust cover. Special alloy contact to prevent Thermal E.M.F.



Specify Clarostat! That's all. For the name stands for the most advanced design and refined construction in control devices. It stands for the products of an organization long experienced in supplying the most rigid demands of the electronic industry. And it stands for controls of any resistance range, regulation curve, combination or arrangement to meet your exact specifications. Specify *Clarostat*—and you solve your control problems!

A complete line of controls:—

Wire Wound—Straight or tapered resistance change. Large or small bakelite housings. With or without dust cover. Bushing and shaft insulated or "grounded." Line switch attached if desired.

Graphite Element—Straight or tapered resistance change. Completely enclosed in bakelite shell. Frictionless positive drive contact roller. With or without switch.

Compression Rheostats—for the control of the heavier currents in electronic tube and associated circuits. Any resistance range from 10 ohms up to 10 megohms. Several sizes—7, 20, 80 and 250 watts.

CLAROSTAT MFG. CO., INC.
285 N. 6th St., Brooklyn, N. Y.

CLAROSTAT
TRADE MARK
REG. U.S. PAT. OFF.

RELAYS SENSITIVE HIGH SPEED

SENSITIVE RELAYS—for currents of 100 Micro-amperes and up—for changes of current at 50 micro-amperes and up.

HIGH SPEED RELAYS—Speeds to 25 makes and breaks per second at 25 milli-amperes operating current.

POLAR RELAYS—High speed and Sensitive—Single winding or differential winding—Fine adjustments for Biasing.

Send Us Your Requirements

RECORDERS DRAW-OFF MOTORS TAPE REELS

Complete Equipment for Recording Radio and Cable Signals always in stock

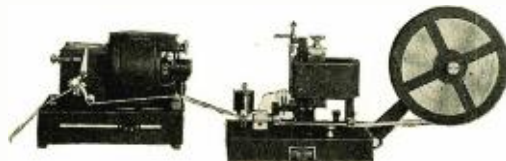

Siphon Recorders—sensitive to one milliampere.

Send for Description

COMPLETE MANUFACTURING SERVICE

Engineering—Development Models—
Experimental

Small Lot and Quantity Production

J. H. BUNNELL & CO.

(Established 1878)

215 Fulton St., New York City

NEW DEVELOPMENTS OF THE MONTH

A FLAT TYPE MOLDED RESISTANCE UNIT

As a result of extensive development work expended over a number of years, there is now available a new type of resistance unit. These units, having been developed as a result of an endeavor to improve both design and characteristics are decidedly new and practical.

The main idea behind their development was to produce a unit which could be molded from a satisfactory material with the connecting lugs molded into the material and the resistance value predetermined so that no alteration or treatment would be necessary once they were molded. After extensive experimenting a satisfactory material was produced, which molded well and had characteristic advantages for its use as a resistance medium. This material is composed of carbon with a binder of a complex mixture of elements, which when molded is tough and not easily subject to changes in resistance value. In order to increase the heat dissipation of the unit and thereby enable the reduction in physical size, a flat design was adopted in place of the usual round style.

The completed units are flat in shape, and provided with various types of lugs for

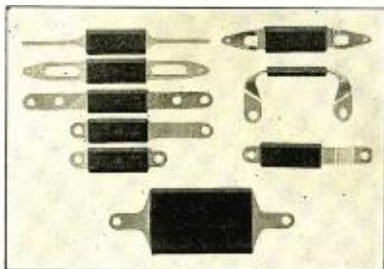

mounting or soldering. The material itself is non-hygroscopic and is not subject to failure except from very high temperatures. High voltage discharges and overloads do not permanently affect its resistance value and it will always return to within 2 per cent of its original value.

A distinctive characteristic of these units is that they are absolutely noiseless in operation when used within their normal rating. This extremely important characteristic is due both to the resistance material itself and to the method of "molding in" the lugs. They are manufactured by the S. S. White Dental Mfg. Co., Philadelphia, Pa.

TRANSMITTER CONDENSERS

The Dubilier Condenser Corporation, 4377 Bronx Blvd., New York, is marketing efficient mica condenser units.

Stacked so as to provide the necessary voltage rating in the handling of the high voltages encountered in transmitting work and carrier current applications, the Dubilier types 850-1-2-3 mica transmitting condenser units are proving highly practical. These condenser units make use of an isolantite tube fitted with cast metal top and bottom as the housing for the capacitor. The top and bottom members are the terminals, so that when the units are stacked, they are automatically connected in series. The outstanding feature of the units, according to the Dubilier Condenser Corporation, New York City, is the handy design. No space is wasted in the instal-

lation of these units. Also, maximum insulation is provided between terminals, since the entire length of the insulator body separates the two terminals of the capacitor. These units are widely employed for radio telegraph and telephone transmitters and for carrier current applications. Single units are available in a-c. voltage rating up to 50,000, and in a wide range of capacities.

MEGOHM DECADE RESISTANCE BOX

The Shallcross Mfg. Company, Collingdale, Penna., is making the 900 series decade resistance box herewith illustrated. The wide range of high resistances available in these resistance boxes now



provides comparison standards for high resistance measurements, insulation measurements and other uses in many fields of research and engineering such as: physical, electrical, radio, geo-physical, electron tube, physical chemistry, x-ray, sound recording and industrial laboratories.

RADIO SERVICEMEN'S OUTPUT METER

An output meter for use by radio servicemen has been announced by the Jewell Electrical Instrument Company of 1642-U Walnut Street, Chicago, Ill. Radio men have found that the human ear cannot be

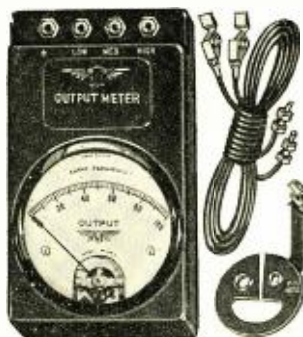

depended upon when making accurate adjustments of radio frequency stages. This instrument allows the serviceman to see when the point of best adjustment is reached. Three measuring ranges are provided to adapt it to the output circuit of any receiver. Furnished with leads, test clips and socket adapter.

HAMMARLUND CONDENSERS

The picture here shown illustrates the laboratory care exercised by the Hammarlund Mfg. Company in matching condens-



ers. The device permits of rapid and accurate adjustments to insure exact capacities in the manufactured units.

NEW "CONOID" R-F. COILS

A superior quality at a low cost is the combination that the Premier Electric Company claim for their new "Conoid" type radio-frequency coils (patents pending) and which, due to their small size are meeting with favor among manufacturers of midget sets and auto-radios.

Engineers readily appreciate the design



and construction of these "Conoid" coils from an efficiency standpoint, as the windings are self-supporting and are not wound on a core, which practically eliminates all absorption losses, and greatly reduces high frequency loss.

This construction also permits of a concentrated field from the "Conoid" type of winding, permitting unusually small cans to be used without loss of efficiency. The cans are soft copper 2 in. in diameter and 1 9/16 in. deep.

"Conoid" r-f. coils are furnished in matched sets, and manufacturers desiring to investigate the merits of this new coil will be furnished a set free of charge and without obligation by writing the Premier Electric Company, Grace and Ravenswood Avenue, Chicago, Illinois, and mentioning this magazine.

NEW VOLUME CONTROL WITH "DEAD" SHAFT AND BUSHING

Of especial value in the control of the new variable-mu tubes, the new Clarostat wire-wound volume control with "dead" or insulated contact arm and mounting bushing has just been announced by the Clarostat Mfg. Co., Inc., of 285 North Sixth St., Brooklyn, N. Y.

This improved model of the Clarostat control makes the use of insulating mounting bushings unnecessary as all exposed parts are out of the electrical circuit.

It is supplied with a dust cover or not as desired and may also be had with 110-volt switch attached.

THE TREND IS TOWARDS FULL VISION

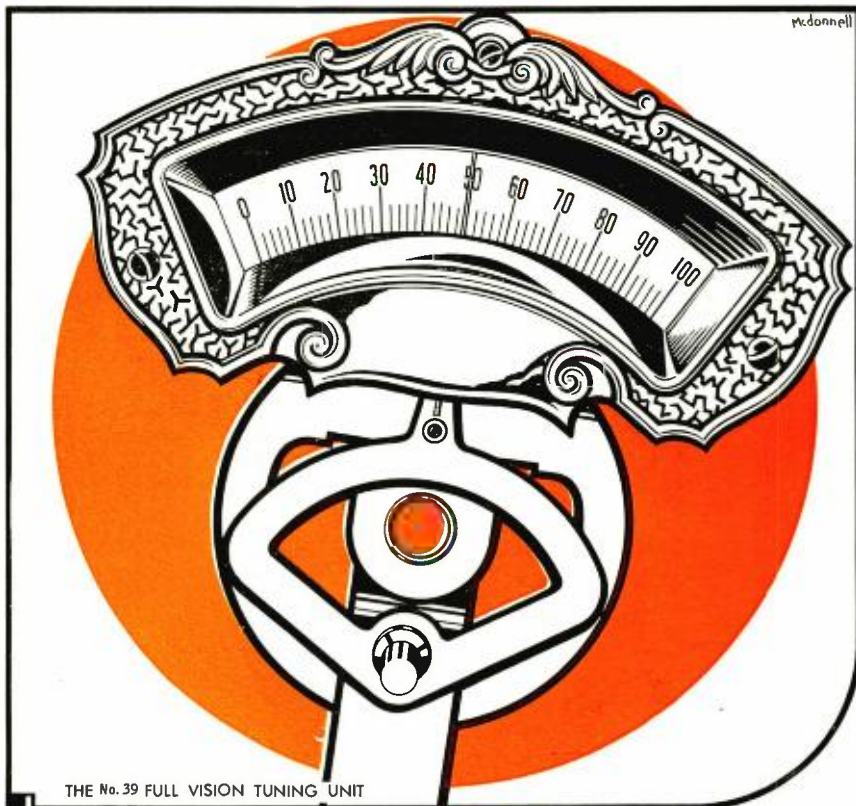

THE No. 39 FULL VISION TUNING UNIT

In accordance with the present trend toward full vision control, Crowe has designed and built several tuning units that answer every modern radio engineering requirement

The No. 39 with escutcheon No. 8506 is shown above, typifying the new design in tuning units.

New developments in tuning units will be on display at our booth (No 108) at the RMA Trade Show at Chicago. New open pattern escutcheons will also be shown, as well as many suggestions for the design of your own exclusive escutcheons.

YOU
are invited to visit
our display at Booth
108 during the RMA
Trade Show at the
Stevens Hotel, in
Chicago, June 8 -
12, inclusive.

• • **CROWE**
NAME PLATE & MANUFACTURING CO.
1745 GRACE STREET • CHICAGO ILLINOIS

OUR FACTORY PRECISION

Is Insured By

The Summerill Box

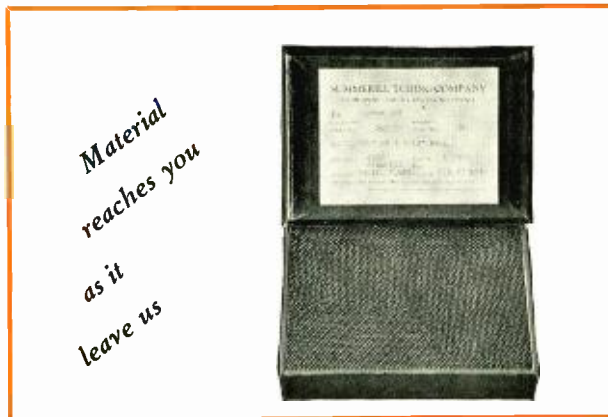

SUMMERILL SEAMLESS NICKEL TUBING

●
PROMPT DELIVERIES
any where—any time
—any quantity

The scientific care used in making Summerill Seamless Nickel Tubing is carried through until it reaches you. It is packed in a sturdy box carefully made to insure the contents against all shocks in transport. It assures perfect condition of the tubing when it reaches you.

EVERY care is exercised so that Summerill tubing is chemically pure—that accuracy is maintained in factory procedure.

PACKED in the Summerill box, tubes reach customers as fine as they are here.

LET US send you a sample for your engineering and production departments

The Summerill Tubing Co.

founded 1899

Bridgeport,

Pennsylvania

Philadelphia District

TUBING *by* SUMMERILL

COIL WINDING MACHINERY

The Universal Winding Co., Providence, R. I., is marketing the No. 84 coil winding machine with four-coil attachment for various coils used on radio receiver manufacture—intermediate transformer coils, antenna loading coils, r-f. chokes, and other coils of universal or cross-winding construction. The winding accuracy essential to elec-

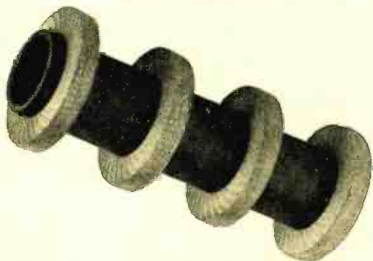

trical efficiency in "cross-wound" coils is assured through the use of the No. 84 Universal coil winding machine with its "gainer mechanism" for positive control of wire-turn spacing. Realizing that the rate of output featured in a machine for single-coil winding is somewhat restricted, the No. 84 machine has now been made available for producing four coils of like specifications simultaneously. With this greatly improved mechanism, increase in daily output per machine is obtainable.

NEW INVERTIBLE TYPE CONDENSER

The Elkon Division of P. R. Mallory & Co., Inc., announces the release of a new inverted type 8 mfd. condenser. This new type has all the outstanding features of the regular Elkon non-aqueous hi-volt condensers and differs only in that it conforms to the standard dimensions of the inverted round 8 mfd. type.

Elkon condensers have many features which appeal to the set manufacturer. As implied by the term "non-aqueous", they



contain no free water; they can meet any d-c. operating voltage requirements up to 450 v. d-c.; low temperatures are not injurious; they can withstand without injury peak voltage of all properly designed sets; they are stable in operation to guard against electrical and mechanical variations that would affect the action of the circuit, and they have an extremely low normal rated leakage.

With the addition of the new inverted type 8 mfd. condensers, Elkon non-aqueous hi-volt condensers are now adaptable to all mounting arrangements in use by the set manufacturers.

DECADE RESISTANCE BOXES AND ATTENUATORS

A new complete line of decade resistance boxes, attenuators, and voltmeter multipliers of unusual features is announced by The Daven Company of Newark, New Jersey.

The decade resistance boxes are manufactured in combinations of from one to six decades in a box, ranging from 1 ohm to 100 megohms per decade. All resistance units, with the exception of the 1/10th ohm steps are the well known noninductive Super-Davohms. The boxes are supplied with special taps to facilitate their use as voltage dividers, coupling resistors for photoelectric cell amplifiers, voltmeter multipliers, special bridge circuits, standards, etc., thereby making it a welcome essential piece of apparatus for any experimental laboratory. The standard accuracy of Daven decade boxes is 1/10 per cent plus or minus. Lower priced boxes are available with an accuracy of 1/4 per cent. and 1/2 per cent. plus or minus.

The new Daven attenuator is a non-inductive high precision instrument with an accuracy of 2 per cent. plus or minus, built to the customer's specifications as L, T, or H pads in any range of impedance and attenuation. All attenuators are enclosed in a dust proof container.

BEAT-NOTE OR HETERODYNE AUDIO OSCILLATOR

The beat-note or heterodyne oscillator No. 302, manufactured by Wireless Egert Engineering, Inc., 179 Greenwich St., New York, generates audio frequencies by means of the heterodyning of two radio frequencies differing by an audio frequency. The audio frequency generated by this oscillator is continuously variable from 40 to 15,000 cycles per second. Four tubes are used, two of which are the radio frequency oscillators, while the remaining two are detector and amplifier, respectively. All four tubes are of the two-volt type. The voltage output of the instrument remains practically constant over the entire range. A calibrated curve is provided with the instrument recording audio frequencies against the dial reading. The

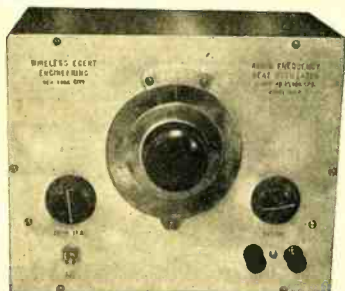

instrument is ruggedly constructed, employing the best apparatus available. A handle can be placed on the cabinet if a semi-portable unit is required. An aluminum panel and black crystallized cabinet is used. This instrument is especially valuable as a source of variable audio frequencies in the testing of loud speakers, amplifiers, microphones, and acoustical apparatus in general. Dimensions 10" x 8" x 7 3/8". Weight 6 lbs.

NEW LINE OF DEJUR-AMSCO DIALS

Literature describing a complete line of tuning accessories by DeJur-Amsco Corp., 95 Morton St., New York, including dials, dial lights and escutcheons, is available to the manufacturer and other interested parties. Approximately one hundred different styles of dials are manufactured by this Company. The six general designs are full

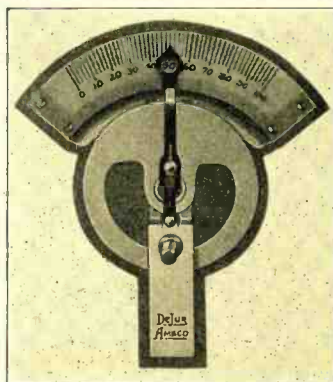

vision, sector vision, sector vision bevel, direct drive, direct drive bevel and large drive.

The dials are available in tan and white scales, with either one hundred division or kilocycle graduating. A variety of handsome escutcheons adapt the dials to practically every cabinet design from the period console to the modernistic midget.

LYNCH METALLIZED RESISTORS PIGTAIL AND CARTRIDGE TYPES

Lynch Metallized Resistors, made by the Lynch Mfg. Co., General Motors Bldg., New York City, now employ new "K" filament. This new type filament is the result of many months of intensive research.

It is the same general type the trade is acquainted with—but stronger and more durable and therefore able to meet the more rigid specifications now demanded. Closer tolerances are possible with "K" filament, and it is said to have the capacity to stand greater overload.

Another outstanding improvement is the



molded end cap. The cap itself is tapered for insertion in standard cartridge type mountings, where interchangeability is desired. Tinned copper pigtails, when specified, are molded into the caps and are not soldered or strapped thereto. By this method, a clean, sure 100 per cent contact between resistance element, cap and pigtail is made certain.

The special ceramic casing is of sturdy construction and maximum heat dissipation. It will withstand more than average shocks and jars, as well as minimize possibility of damage by crushing.

Lynch Metallized Resistors are supplied in 1/2, 1, 2, 3 and 5 watts, cartridge and pigtail types. There is also the Ignition Resistor for use in automobiles when radio sets are used.

R. C. SPRAGUE TALKS ABOUT NEW VISIVOX

"The Sprague Specialties Company entered the field of home talking moving pictures after mature consideration of the possibilities. We realized that if a large production business were to be established on this line, that two elements were vitally necessary.

"In the first place, it would be important to obtain assurance as to the availability of all types of films and records for home talkies. Without the material to give entertainment in the home, the machine would be of very little use.

"The second element was the devising of a new apparatus that could be counted upon for fool-proof efficiency and simplicity—and which could be manufactured in quantity to sell at prices hitherto unheard of in this particular industry. The popular priced field seemed to us to be the only one worth considering. As our plans progressed, we realized there was a very genuine interest in this machine, not only because of its technical development, but because of the tremendous and comparatively untouched field of home entertainment that lies in this direction.

"We have been more than gratified, and the Visivox Division of our plant in North Adams is now in 100 per cent full production on this line."

DUOVAC INTRODUCES NEW SILENT TUNING DEVICE

Automatic volume control in radio sets has been accepted as a distinct improvement. At the same time it has proven itself a liability due to a seeming loss of sensitivity and a rather high noise level which it introduces.

Tune-A-Lite, a new type of gas-filled tube, developed by the Duovac laboratories, after a circuit designed by Professor Alexander Senauke, eliminates these disadvantages and permits full benefits of automatic volume control.

Tune-A-Lite makes possible silent tuning. Every audible station in the general broadcast range can be brought in even though the volume control is turned down to a point where no sound issues from the speaker.

The LAST WORD
More Safety
Less Cost

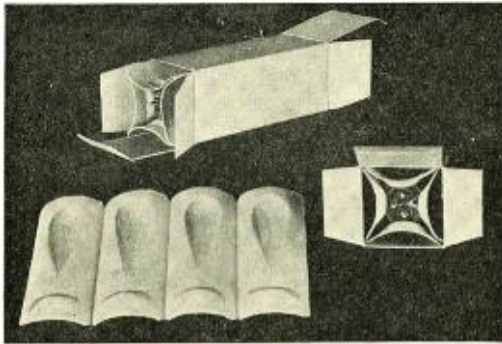

HOLED - TITE RADIO TUBE WRAPPER which is revolutionizing tube packing.



Check these features:

- 1** Wrapper is light and form fitting and designed especially for each size of tube. Consequently, it provides suspension and perfect protection.
- 2** Suspension packing protects against lateral shocks and distortion of elements.
- 3** Tube can be tested without removing from carton, without tearing or defacing the wrapper.
- 4** Wrapper is easily and quickly handled, even by unskilled packers.
- 5** Wrapper costs less than any other packing.

Holed-Tite Wrappers are made for all types of tubes to fit the standard bulb sizes.

Write for samples and prices today.
 Protect your tubes; save money.

HOLED-TITE PACKING CORP.
 220 E. 42nd St., New York City
 Affiliated with International Paper Co.

YOUR
Pentodes and New
R.F. Tubes Deserve

"SEALEDGED"

REG. U.S. PAT. OFF.

—the 99+⁺% Pure Nickel Cloth, with the distinctive sealed unraveling edge «

Micro photograph of "Sealedged". Carefully note the weave and edge.



"SEALEDGED" is the ideal component material for the new variable-mu tubes and pentodes. Only the purest nickel wire enters into the composition of this cloth. Even weave and smooth finish are obtained by our special precision machinery. Costs only slightly more than ordinary raw cut wire cloth.

We also furnish Molybdenum screen for special applications. Details on request.

NEWARK WIRE CLOTH CO.
 358-372 Verona Ave.,
 NEWARK, N. J.

Without any obligation on our part
 Please send sample and details of "Sealedged."
 Please send representative.

Name

Firm

Street

City State.....

Tape Measure or Micrometer?



A good mechanic does not use a tape measure.

He uses a micrometer—an instrument upon which he can depend for accuracy. The tape measure might furnish an idea of size but when accurate measurement is essential he would employ a micrometer.

In the work of testing and servicing Radio sets the instruments employed must possess unerring accuracy. You cannot employ tape line instruments, they must be of micrometer accuracy. There should not be any room for doubt on the part of the service man when he is in contact with the customer's receiver. The tests must reflect exactly the condition of the set.

DayraD Radio Service Instruments Are Recognized As Standard

Because they have stood the test of time. Every DayraD Tube Checker, Analyzer, Oscillator, Test Panel, Voltmeter—Ohmmer, Output Meter or other instrument, although sold for less than other instruments, possess super quality.

See These Service Instruments at Stevens Hotel, Chicago, Week of June 8th, Booth No. B-57

Or if you are not going to the Radio Show send for Catalog which describes and illustrates these various instruments

THE RADIO PRODUCTS COMPANY

5th & Norwood Dept. E. Dayton, Ohio, U. S. A.



Says the Radio Tube Manufacturer:

“Our reputation and therefore our success depends upon the quality of our Tubes; and this reputation-maintaining quality calls for the highest commercial quality possible in each of their parts.

“Such quality can be secured only from an organization with the last word in special machinery and with long and successful experience in the making of tools for, and in the production of, a great variety of such parts.

“Furthermore, that concern must be a sufficient source of supply for all the parts we need. We could not afford to pick up one part here and another part there, among those who are able to produce only a limited variety.

“In short, I demand an organization that is a factor in the Radio Tube Industry comparable to ourselves: dependable, responsible to the utmost. For these qualities are essential to our own stability.

“And finally, Tube Parts manufactured by an organization such as I have specified are priced right; that is, lower than we could manufacture them for ourselves or obtain equal quality for elsewhere.”

Says Goat:

“This is an advertisement of just the kind of concern you have specified.”

Goat Radio Tube Parts, Inc.
33 35th STREET, BROOKLYN, N.Y.



AMPLION



TYPE T M
\$65.00
Less Stand



TYPE H M
\$25.00



TYPE J M
\$25.00
Less Stand

Transverse Current

MICROPHONES

Write for 20-page catalogue and price list describing microphones, microphone amplifiers, 50-watt power amplifiers, giant dynamic air column units, exponential horns, synchronous and non-synchronous turntables, and complete panel mounted equipment for schools, hotels, hospitals, parks, skating rinks, steamships, airplanes, auditoriums, theatres, etc.

Ask about the PORTOVOX, a complete portable sound system in two pieces for convenient carrying, listing at only \$250.

Amplion Corporation of America
133 W. 21st St., New York City

Insulation that meets the specific needs of Radio

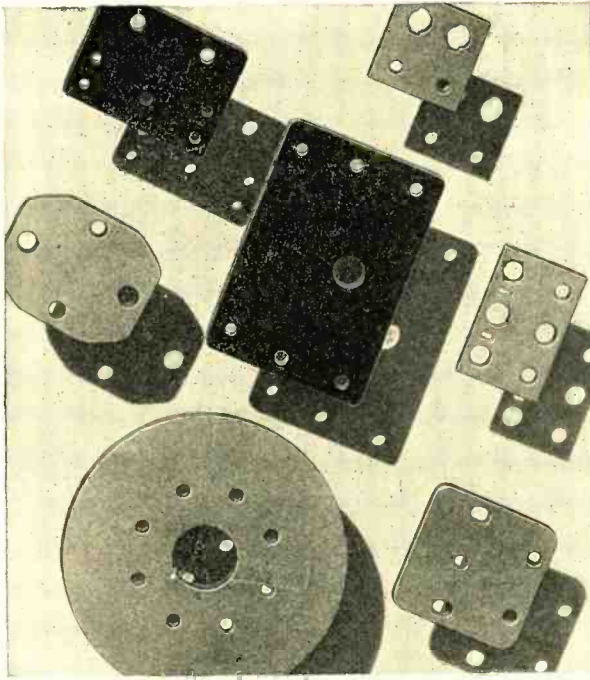

MANUFACTURERS who have tested our special radio grades of hard rubber insulation, X1B and X2B, invariably prefer this material because of its important physical characteristics—mechanical strength and hardness, low moisture absorption and excellent di-electric values.

For many such manufacturers we regularly supply punched, turned or moulded parts and raw materials—rods, sheets and tubes.

Samples and quantity quotations sent on receipt of specifications and blue prints. Write to

AMERICAN HARD RUBBER COMPANY

11 Mercer Street - New York, N. Y.

Sales Offices also at Akron, Ohio and Chicago, Illinois

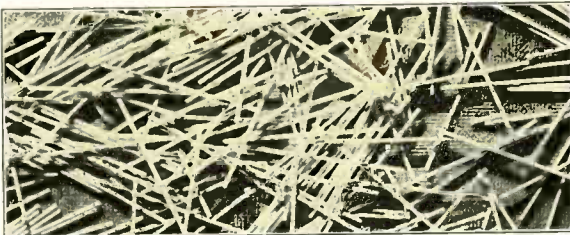

Uniformity

Thousands upon thousands of pieces—each of the exact internal and external diameters called for by specifications—each possessing the same mechanical, chemical, electrical and thermal characteristics—that spells



The brand name of a complete line of quality radio and electrical insulating parts made to fit individual requirements.

Write for data regarding Crolite. Better still, send specifications and drawings so that we may quote on your exact requirements.

HENRY L. CROWLEY & COMPANY, Inc.
Specialists in Severe Service Materials

1 Central Avenue :: :: West Orange, N. J.

M&W.C. 1876

LACQUERS ENAMELS

Specify M & W Lacquers

An ever growing number of Radio Engineers and Production men are realizing the importance of specifying Finishes designed by a manufacturer who understands their requirements. They also know that many others specify M & W products because they are reliable and are specially built for the purpose. A partial list follows—

Chassis Lacquer	Colls
Cadmium Lacquer	Clear Insulating Lacquer
Water Dip Lacquer	Black Insulating Enamel
Bronze Lacquer	Winding Cement
Prismac Enamel	Speakers
Shields	Paper Cement
Clear Lacquer	Metal Cement
Bronze Lacquer	Leather Cement
Cans	Wire Cement
Lacquer Enamel	Voice Coil Cement
Prismac Enamel	Waterproof Paper Enamel

May we have an opportunity to offer suggestions to you?

MAAS & WALDSTEIN CO.
Executive Offices and Plants:
438 Riverside Ave., Newark, N. J.

Chicago Office and Warehouse: 1115 W. Washington Blvd.
Los Angeles Office and Warehouse: 2416 Enterprise Street.

The border of this advertisement is a photographic reproduction of M & W Prismac.

Avail Yourself of the Facilities of Our New Modern Factory—

EASTON

COILS—TRANSFORMERS WIRE-WOUND RESISTANCES

Note
our new
address

Manufacturers who desire to connect with an up-to-date factory specializing in parts for radio sets will find ideal business relations here. Your own designs will be turned out to exacting requirements—you will have the confidence that your production schedules will be met on time.

Our Engineering Department will be pleased to cooperate with you in your design problems. All information will be held in strict confidence.

*Send your specifications—or shall we call?
Samples and quotations furnished promptly.*

EASTON COIL COMPANY
22-19 41st Ave., Long Island City, N. Y.

Give Your Product This Added Feature

DIEHL

RECORD CHANGERS

MOTORS

SOUND PROJECTION

TELEVISION

RADIO PHONOGRAPHS

HOME TALKING PICTURES

No matter how well designed your equipment may otherwise be, performance will largely depend upon the motor drive selected.

Forty-three years of motor manufacturing experience places Diehl in a unique position for developing and producing electric motors to meet the individual needs of manufacturers in the expanding fields of television, home-talkies, sound projection, electrical transcription, public address systems, record changers, etc. The adoption of Diehl motors by foremost radio-phonograph set manufacturers is sufficient proof of their correct and dependable performance.

Standardize on Diehl—and give your machines the added feature of a motor drive which has trade recognition and acceptance.

DIEHL MANUFACTURING COMPANY

Electrical Division of the
SINGER MANUFACTURING COMPANY

ELIZABETHPORT, N. J.

Atlanta Boston Chicago New York Philadelphia

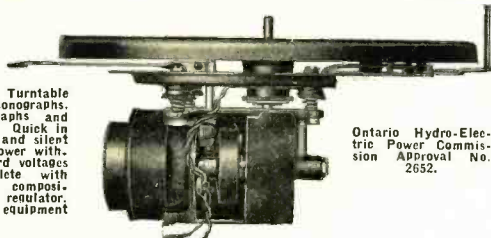

The Diehl "Aristocrat" Turntable Motor—custom-built for phonographs, combination radio-phonographs and sound projection machines. Quick in starting, uniform in speed and silent in operation. Abundant power without vibration. All standard voltages and frequencies. Complete with mounting plate, molded composition turntable and speed regulator. Built-in Automatic Stop equipment optional.

Ontario Hydro-Electric Power Commission Approval No. 2632.

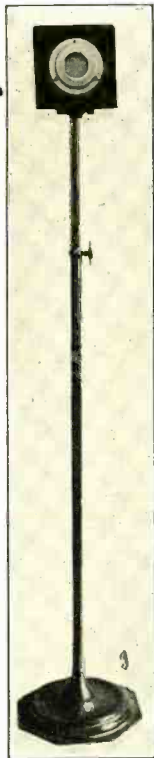

Sound Amplifier Systems

Input equipment for radio broadcasting and sound recording.

Centralized radio and public address systems for hotels, auditoriums, churches and amusement parks.

Astatic condenser microphones.

Write for descriptive bulletins.

R. C. Powell & Co., Inc.

350 Madison Avenue,
New York City

Licensed under Loftin-White patents pending.



Shallcross Multi-Range Kilovoltmeter Multipliers

for A. C. and D. C. measurements up to 20,000 volts.

Resistance 1000 ohms per volt and higher. Described in our Bulletin 700-K.



Shallcross Megohm Decade Resistance Boxes

Incorporating the highest grade non-reactive, wire-wound resistor units and the most modern methods of insulation to guarantee *Low Leakage*.

No. 935—Two Decade $10 \times (.01 + 0.1)$ Total 1.1 Megohms
No. 945—Two Decade $10 \times (0.1 + 1.0)$ Total 11 Megohms
No. 960—Two Decade $10 \times 1.0 + 5 \times 10$ Total 60 Megohms

Described in our Bulletin 900-K.

Write for these two bulletins.



Shallcross Mfg. Company
ELECTRICAL SPECIALTIES
700 PARKER AVENUE
Collingdale, Pa.



We also manufacture Super Akra-Ohm Wire-Wound Resistors

The MADISON

Overlooking Ocean at Illinois Avenue
ATLANTIC CITY, N.J.

Now is the time to visit with Spring in its natural setting . . . splashing surf and sparkling sands—sea air and sunshine . . . and to meet Summer as it comes swinging in on the wings of a Southern breeze.

For the better enjoyment of these seasons, the Madison is so dedicated. It offers a touch of quiet seclusion in the smartest, liveliest part of the resort—provides service attentive to even the least of details surrounds its guests with the charm of authentic Colonial appointments.

Rates for either American or European Plan are most attractive.

EUGENE C. FETTER,
Managing Director



FETTER & HOLLINGER, INC.

Escutcheons — DIALS and NAME PLATES — LICENSE PLATES —



Full Vision Escutcheon—about half actual size.

Our large and modern plant affords excellent facilities for the speedy production of your requirements in etched and lithographed also embossed metal specialties. A large variety of stock dies enables Radio Manufacturers to effect great savings on escutcheons, for regular models, Midget sets, and auto radio sets.

Send your blueprints—our Art Department will gladly submit original sketches for your approval.

General Etching and Mfg. Co.

MANUFACTURERS OF

ETCHED AND LITHOGRAPHED
METAL PRODUCTS

3070-82 W. Grand Ave., Chicago, Ill.

JENKINS & ADAIR Condenser Transmitter

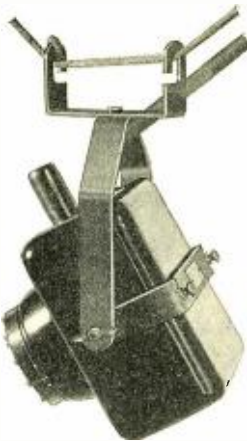

Type D-6

Patented U. S. A. No. 1790505
Des. No. 83540 And Foreign

A high quality sound translating device for broadcasting, recording sound measurement and announcing. Output impedance 200 ohms and 50 ohms. Has substantially flat response curve and output — 30 D. B.

Actuator response curves furnished for precision applications.

We have a large stock of accessories such as stands, suspension clamps, microphone booms, connectors, cable, etc.

Illustration shows D-6 Condenser Transmitter \$225.00 and Type C Clamp \$8.50. Both prices for U.S.A. net F. O. B. Chicago.

Write for Bulletin 6-E

JENKINS & ADAIR, INC.
ENGINEERS

CHICAGO, U. S. A.

Cable Address: JENKADAIR

Phones, Keystone 2130 3333 Belmont Avenue

British Offices: 76 Old Hall Street, Liverpool, England
40 Buckingham Gate, London, SW1, England

French Office: 16 Rue de Chateaudun, Asnières, France

Mexican Office: Av. 5 de Mayo 10, Mexico D.F., Mexico



All Kester Solder Exceeds Class A Purity Specifications of the A.S.T.M.

“Because
it’s safe, Smith!”

“I’ve been making sets for years, and I know there’s only one safe soldering flux for our kind of work—rosin. Kester Rosin-Core Solder carries a rosin flux inside itself—and it’s a plasticized rosin that even age can’t impair!”

Kester Rosin-Core Solder always goes the best one better. Its virgin tin and lead exceed even the A. S. T. M. Class A specifications for purity. It’s fast, too—a time and labor saver. Radio and electrical manufacturers who use it see production costs go down at the same time standards of efficiency go up!

Write to our Industrial Development Department. Let us untangle your knotty solder problems. We can do it!

Kester Solder Company, 4224 Wrightwood Avenue, Chicago, Illinois. Incorporated 1899.

KESTER
FLUX-CORE
SOLDER

Acid Core • Paste Core • Rosin Core

Standardize On

LYNCH METALLIZED RESISTORS

Using the New Type "K" Filament



½, 1, 2 and 3 Watts Cartridge and Pistal Types

Precision Wire Wound Cartridge and Pistal types

Lynch Features:

- Closer Tolerances
- Greater Overload Capacity
- Maximum Heat Dissipation
- Greater Safety Factors
- Moisture Proof—Noiseless
- Pistals molded in—not strapped or soldered, insuring positive contacts

Service Costs !

Steal PROFITS !

You can materially reduce overhead expense by use of products that are guaranteed to give perfect performance.

Write for data on curves and other tests of this most advanced resistance unit available today. Samples submitted for test on receipt of specifications.

LYNCH MFG. CO., Inc.,
Dept. RE, 1775 Broadway, N. Y.



Astatic Microphone
Type 230

Many features including signal lights and three values of output impedance makes the 230 of outstanding value for Public Address, Recording and Broadcast use.

Bulletin No. 3 on request.

ASTATIC MICROPHONE LABORATORY
YOUNGSTOWN, O.

New York: R. C. Powell & Co., Inc. 350 Madison Ave.
Chicago: Royal Recording & Film Studios 661 N. Michigan Ave.

BRASS—BRONZE—COPPER

NICKEL SILVER—ZINC

PHOSPHOR BRONZE

In Gauges .001 and Thicker. 1/16" to 16" Wide

HOT TIN COATED METALS IN COILS AND STRIPS

THE BALTIMORE BRASS CO.
1206 WICOMICO ST., BALTIMORE, MD.

We Cater to Laboratories—Broadcasting Stations—Talking Movies, Etc. Parts for any and every item you may need always on hand. Call on us for your requirements



The Home of RADIO

45 VESEY STREET, NEW YORK CITY

Premier

AUTO RADIO Control



Universal mounting, steering column or instrument board—key lock switch—illuminated dial—indestructible pressed steel—black rust-proof finish—small size 3½" x 4¼" — a real job. Manufacturers inquiries solicited.

PREMIER ELECTRIC COMPANY
Established 1905

1802 Grace Street Chicago, U. S. A.

BETTER RADIO PERFORMANCE
with **AMPERITE**

AMPERITE automatically regulates line voltage fluctuations. Improves tone, protects tubes and other equipment, reduces free service. Easily installed in 5 minutes without chassis changes. Makes your careful laboratory specifications mean something in better set performance.



AMPERITE Corporation
561 BROADWAY, NEW YORK

AMPERITE

Self-Adjusting
LINE VOLTAGE CONTROL

Write Dept. RE-6 for live profit-making proposition.



NICKEL WIRE CLOTH

for the

RADIO TUBE INDUSTRY

Any mesh woven accurately to your specifications.

"CLEVELAND"

Wire Cloth renowned for its Uniformity, its Superiority, its Durability.

Advise us of your Requirements

The Cleveland Wire Cloth & Manufacturing Co.
3571 E. 78th Street, CLEVELAND, Ohio



RADIO APPARATUS TESTING



Life tests and characteristics of vacuum tubes. Calibration of all kinds of instruments. Determination of inductance and capacitance at various frequencies. Resistance measurements, motor tests, magnetic tests, etc.

Electrical Testing Laboratories
80th St. and East End Ave.
New York



Know by Test

ACME TRANSFORMERS ARE BETTER

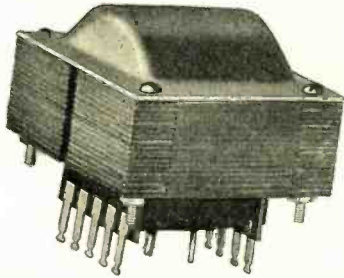

See the Acme Exhibit
Booth 11
R. M. A. Show



The Acme Electric & Mfg. Co.
1440 Hamilton Ave., Cleveland, Ohio

Micro phones

HOME RECORDING » » »
PUBLIC ADDRESS » » » »
STANDARD BROADCAST

**Kellogg Switchboard
and Supply Company**
CHICAGO

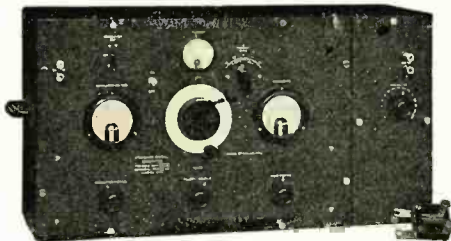

Type 403-C Standard-Signal Generator

Price \$600.00

RECEIVER TESTING

Throughout the industry General Radio standard-signal generators are making the standard I. R. E. and R. M. A. receiver tests. In the development laboratory and in the production line these instruments measure the sensitivity, selectivity, and fidelity of broadcast receivers.

Consulting engineers for progressive broadcast stations are also using this instrument for making field-intensity surveys, thus determining the actual effective coverage of the transmitter.

*Write for a copy of Catalog
F-A6 which describes this
instrument in detail.*

GENERAL RADIO COMPANY
Offices, Laboratories, Factories
CAMBRIDGE A, MASSACHUSETTS

Carbon Resistors,
Wire Wound Resistors,
Strip Resistors,
Sealdohm Resistors,
Voltage Drop Resistors.



RF Coils

Cartridge Condensers,
Filter Condensers,
By-Pass Condensers,
Molded Bakelite Condensers,
Canvas Bakelite Condensers.

EL-MENCO



ANNOUNCEMENT TO SET MANUFACTURERS

The Electro Motive Engineering Corporation now offers a most complete line of resistors and condensers. The line of resistors takes in carbon resistors, synthetic resistors, wire wound resistors, strip resistors, sealdohm resistors and heavy duty voltage drop resistors. The line of condensers includes small cartridge type by-pass condensers, filter condensers, molded, and canvas bakelite condensers. The new additions are held to the same exacting standards as adhered to in the past. The best grade of linen paper is used in the manufacturing of the cartridge condenser. It is thoroughly impregnated and has a high insulation resistance and low power factor. These condensers are supplied in capacities from .045 mfd. to ½ mfd. These condensers are very efficient and economical and can readily be adapted to fit the requirements of various design chassis.

"QUOTATIONS AND SAMPLES FURNISHED ON REQUEST."

ELECTRO MOTIVE ENGINEERING CORP.
797 East 140th St. New York, N. Y.

Rocke International Electric Corp.

15 Laight Street, New York City

Export Managers
Radio — sound equipment — Electric Products



CONDENSER TISSUE

Stocks of all standard sizes
in
New York and Chicago

The Old Masters Paper & Pulp Corp.
154 Nassau Street, New York City



SPOT WELDERS

From .0005 To 1/2"
Combined Thickness

*Let us solve your
Spot Welder Problems*

EISLER ELECTRIC
76J South 13th Street,
NEWARK, N. J.

CUT NICKEL and FLAT ENDS for Radio Tubes



between .070 and .006 dia.
±.002"—no burrs—every piece straight
Capacity 10,000,000 pieces daily

*Small metal parts to your blue print. 100 to 675,000 pieces per lb.
What you cannot make, we will.*

Art Wire and Stamping Company
18-22 Boyden Place, Newark, N. J.

CLAMP NAILS

For All Mitered Joints

Send for
FREE Samples
and Catalog

★ So good that the Best Craftsmen can find
making better. . . . So economical that
the Master of the Trade has produced
nothing else in our anything cheaper.

Used in
Millwork,
Cabinet
Construction,
Furniture,
Etc.

CLAMP NAIL CO.
4522 Palmer St.,
CHICAGO, ILL.

WIRE

Quality wire for every type of hook-up
"Alpha" a slip back braided hook-up wire made
under a patented process.
Alpha "HiTension" Wire (colored Rubber)
BARE-TINNED-ENAMELED-RUBBER COVERED
—CABLES TO SPECIFICATION—

ALPHA WIRE CORPORATION
52 Howard St., New York City

Baach-International Compound High Vacuum Pumps

We manufacture all sizes of High Vacuum Pumps from 1-200
cu. ft. per min. All pumps tested at 1/2 micron before leaving
factory. Write for details.

INTERNATIONAL MACHINE WORKS, Inc.
527-529 Thirty-Second St., Union City, New Jersey

MICROPHONES

All kinds \$10.00 to \$350.00

For—Home Recorders, Type S. G. P.	List \$10.00
For Public Address Work, etc., Type S. S.	List \$25.00
Standard Broadcast Model, Type S. G. M.	List \$45.00
Standard Broadcast Model, Type S. G. S.	List \$62.50
Condenser Type for film and record recording, Type S. G. C.	List \$250.00

Also desk, floor stands, covers and etc. Expert Microphone Repairs.

SILVERLEAF MICROPHONE COMPANY
2658 Pasadena Ave., Los Angeles, Calif.
Midwest Distributors—Dungan & Sternfield—Radio Sales, Inc.
1507 Michigan Ave., So. Representatives wanted

CONDENSER PAPER

182 Cornelson Ave. — Mills at — Newark Ave.
Jersey City, N. J. Elizabeth, N. J.

PETER J. SCHWEITZER, Inc.,
200 Fifth Ave. New York

Stampings

Pressed Metal for Radio Industry

Steel, Aluminum, Copper, Brass and all Alloys
Send Inquiries and Drawings

METAL SPECIALTY CO. 1533 Riverside Dr.
Cincinnati, Ohio

BARE AND TINNED COPPER WIRE

For All Purposes
Fine Sizes Our Specialty

SPARGO WIRE COMPANY
ROME, NEW YORK
Established 1885



GEARS

In Stock—Immediate Delivery

Gears, speed reducers, sprockets, thrust bearings,
flexible couplings, pulleys, etc. A complete line is
carried in our Chicago stock. Can also quote on
special gears of any kind. Send us your blue prints
and inquiries.

Write for Catalog No. 200
CHICAGO GEAR WORKS
769-773 W. Jackson Blvd., CHICAGO, ILL.

The Home Hotel of New York

Homelike in service, appointments and
location . . . away from noise and con-
gestion, yet but a few minutes from
Times Square . . . garage facilities for
tourists.

Room and Bath from \$3 single, \$4 double—500 rooms
Home folks will like this hotel

HOTEL

ELLIS MICROPHONES AND ACCESSORIES

WRITE FOR DETAILS

ELLIS ELECTRICAL LABORATORY
Sales Corporation
337 WEST MADISON ST. CHICAGO, ILLINOIS



BRETTON HALL

BROADWAY at 86th STREET
NEW YORK

GE Textolite Laminated

A
"GENERAL ELECTRIC"
PRODUCT

WHEN you look at a piece of Textolite laminated you see only the physical substance—yet behind that substance is a vast organization.

Research laboratories, world-famous, make constant, unremitting efforts to discover nature's secrets, to seek out new and better methods and materials.

A corps of engineers, with years of experience in the manufacture of Textolite, labor incessantly to improve quality and furnish the best materials available in the industry.

PUNCHING — MACHINING
Sheets — Rods — Tubing
All sizes carried in stock

GENERAL FABRICATING COMPANY

37 East 18th Street, New York City

OUR PROMPT SERVICE—is a valuable asset in co-ordinating your production work.

Brawley felt feet

For MIDGET RADIOS

Equipped with Brawley Felt Feet, receivers can be set directly on a polished surface without danger of scratches or marks. Look into the advantages of Brawley Felt Feet from a sales appealing angle.

Three types—machine screw, wood screw and nail.

Free sample of any type you want



T. R. BRAWLEY FELT COMPANY, INC.
279-29th Street, Brooklyn, N. Y.



TERMINALS AND AUTOMATIC STAMPINGS

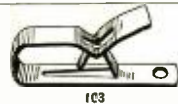

Hot Tinned
Easy To Solder

Send For Our Card Of
75 Samples



F. R. ZERICK MFG. WORKS
68-72 E. 131st St., New York, N. Y.

ELECTROHM (WIRE WOUND) RESISTORS

Durable—Dependable—Accurate—Economical
—Correctly Rated

Four Years' Service in the Equipment of the
New York Stock Exchange

Without a Breakdown

No Other Resistor Can Boast This Record.

Electrohm Resistors are not Fused—Fired—Baked—etc. to any degree beyond the annealing point of the resistance wire; contacts between wire and terminals are not Brazed—Spot-Welded—Soldered—Coated—etc.; all these methods cause nickel oxide which has been the "Waterloo" of resistors for nearly half a century. Electrohm Resistors have proven their superiority. Specify Electrohm Resistors in your new models. Ask your dealer for them. Manufacturers—Send us your Resistor specifications and we will submit samples and quotations.

ELECTRICAL RESISTORS, INC.

179 Riverdale Ave., 24 Onondaga St., Yonkers, N. Y.
Telephone Nepperhan 5658

UNIVERSAL MICROPHONES

"HANDI-MIKE"
MOST EFFICIENT GENERAL UTILITY MICROPHONE KNOWN

List \$10 Complete

The truly perfected single button hand microphone. Two models, "Regular" and "Special Home Recording." Scientifically damped diaphragm, gold plated button, toggle switch, 15-foot cord. Finished bronze or gunmetal. Dealers, write for our "direct deal." Get our complete catalog.

UNIVERSAL MICROPHONE CO., Ltd.
1163 Hyde Park Blvd.
INGLEWOOD, CALIF.

Microphones \$5 to \$350. Also cables, plugs, transformers, mountings, stands, etc. Expert microphone repairs.

Welcome to
New York and
The HOTEL
GOVERNOR CLINTON

Opposite Penn. R. R. Station
New York's new hotel truly expressive of the greatest city, 1200 pleasant rooms each with Servidor, bath, circulating ice water and radio provisions.

ROOMS from \$3.00

31ST STREET 7TH AVENUE

Introducing the Latest MIDWEST Condenser Microphone

The result of years of intensive engineering research—this microphone provides natural, life-like reproduction, responding faithfully to frequencies from 30 to 10,000 cycles. It is free from background noises and is not affected by climatic or temperature changes.

All MIDWEST equipment is
Superior in Quality
Low in Price
Guaranteed

Midwest Broadcast Equipment Co.
6007 Diversey Ave., Chicago, U. S. A.



Condenser Microphone
and Amplifier No. 125
Stand No. S-11



PRESS
DOWN
HERE.

FAHNESTOCK CLIPS

Standard in the Radio Industry
Made in 58 Sizes and Shapes
Send for Samples and Prices

FAHNESTOCK ELECTRIC COMPANY — Long Island City, N. Y.

NEW "CONOID" R. F. Coils



Patents Pending

PREMIER ELECTRIC COMPANY
1802 Grace Street Established 1905 Chicago, U. S. A.

ERRANTI

For AMPLIFIERS and Special Impedance
MATCHING TRANSFORMERS
to meet precision requirements

Write for information.

FERRANTI, Inc.
130 W. 42nd St., New York

WRITE
for it
NOW

New Electrad Catalog

The new Electrad Catalog covers the complete line of Electrad Resistors, Voltage Controls and Loftin-White Amplifiers, including several important new products. In addition, it contains a great deal of helpful information on resistance problems that confront manufacturers and professional service men. In order that we may be certain it reaches only those who can make good use of it, please request your copy on your business stationery, addressing Dept. RE-6.

175 Varick St., New York, N.Y.

ELECTRAD

INC.

LAMINATIONS

for Audio & Power Transformers
SPECIALIZED METHODS—YEARS OF EXPERIENCE
Wide Variety of Stock Standard Sizes
Dimension and Price Sheets on request

We Also Make
PERMANENT MAGNETS—DIES—TOOLS—
METAL STAMPINGS
Facilities for prompt service

Thomas & Skinner
Steel Products Co.

1100 to 1120
E. Twenty-Third St.
INDIANAPOLIS, IND.

When you need something

SPECIAL—

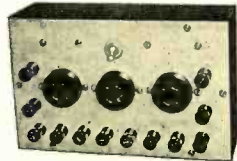

3-Stage Resistance Amplifier
Small, neat and extremely serviceable. Combines maximum amplification with minimum distortion.

Short Wave Superhets
Keying Relays
Frequency Meters
Audio Oscillators
Wave Meters
Frequency Oscillators

If you have a problem in your plant or laboratory, or need special equipment for testing or communication, we are in a position to assist you.

WIRELESS EGERT ENGINEERING

179 Greenwich Street, New York

WE offer to manufacturers interested in

EXPORT

the services of a dependable organization,
well established in the entire foreign field

AD. AURIEMA, INC.

Manufacturers' Export Managers
116 Broad Street, New York, N. Y.

ELLIS MICROPHONES

AND ACCESSORIES

WRITE FOR DETAILS

ELLIS ELECTRICAL LABORATORY

337 WEST MADISON ST. CHICAGO, ILLINOIS



DeWALD

PENTODE RADIO TRIO
Licensed By R.C.A.

A Chassis for Every Purpose
For A.C. or D.C. Currents
Write For Full Particulars

PIERCE AIRO, INC. 506 Sixth Ave.,
New York City

THE Group Subscription Plan for RADIO ENGINEERING enables a group of engineers or department heads to subscribe at one-half the usual yearly rate.

The regular individual rate is \$2.00 a year. In groups of 4 or more, the subscription rate is \$1.00 a year. (In foreign countries \$2.00.)

The engineering departments of hundreds of manufacturers in the radio and allied industries have used this Group Plan for years, in renewing their subscriptions to Radio Engineering.

Each subscriber should print his name and address clearly and state his occupation—whether an executive, engineer, department head, plant superintendent, foreman or technician, etc.

Remember this Group Plan when Your Subscription Expires

(Radio Engineering)

Bryan Davis Publishing Co., Inc.,
52 Vanderbilt Ave.,
N. Y., N. Y.

Los Angeles Chicago Cleveland

On these new tubes

MAKE SURE

OF REPEAT BUSINESS

FIRST!

That's where the real profit is. First sales are loaded with development, production and promotion costs. Forced sales, if possible at all, entail heavy advertising and selling expense. Yes, for real profits you must make sure that your product can win a reputation that brings those low cost REPEAT SALES.

To help make your new tubes "best sellers" and "repeaters," use Fansteel rare metals in every vital part. They run uniform, perform dependably, are accurate in dimension. Fansteel refines them direct from ores and basic salts, under constant control of a laboratory staff that knows tubes and knows what tube makers need.

Fansteel is a dependable source of supply and is prepared to furnish a metal just right for your use, from a wide line of rare metals and standard or special alloys. Large stock for immediate deliveries.

FANSTEEL
Rare Metal Wire and Sheet

-
- For Grids**
- For Plates**
- For Filaments or Heaters**
- For Hooks, Springs**
- Support Members**
- For Screens**
- For Special Uses**

Write for samples and prices or ask for a representative to call

FANSTEEL PRODUCTS COMPANY
INC.
North Chicago, Illinois

WANT SAMPLES?

Just write here metal wanted, dimensions wire or sheet, and use intended; clip coupon to letter-head and mail.

TANTALUM · TUNGSTEN · MOLYBDENUM
and RARE METAL ALLOYS

DEPENDABLE

QUALITY — UNIFORMITY
SERVICE

ON

WAXES — & — MELTABLE
INSULATING and WEATHER-
PROOFING COMPOUNDS

WAXES—All kinds.

IMPREGNATIONS—Condensers, Coils, Rubber-
Covered and Weather-Proofed Wire, Telephone
and Electrical Cables, Etc.

SEALING COMPOUNDS—Coils, Condensers,
Batteries (Wet & Dry), Pot Heads, Cables, Wir-
ing Devices and Specials.

FINISHING—All grades of Weather Proof and
Rubber-Covered Wire.

SPECIAL COMPOUNDS



35th St. & Maplewood Ave.
Chicago, Ill.

"For over 35 yrs."

ROEBLING

WIRE—Antennae (plain or enameled). Con-
necting and Ground (Rubber covered, braided
or plain).

STRAND—Antennae (plain or en-
ameled)—Double Galvanized.

BUS BAR—Litzendraht-Loop

MAGNET (Cotton or Silk)

WIRE PRODUCTS

JOHN A. ROEBLING'S SONS CO.
Trenton, N. J. Branches in Principal Cities

INDEX OF ADVERTISERS

A		E		M
Acme Elec. & Mfg. Co., The.....	77	Electro Motive Engineering Corp.....	77	Mallory & Co., P. R.....
A. L. Aurland, Inc.....	80	Elkon Division.....	18, 19	Metal Specialty Co., The.....
Aerovox Wireless Corp.....	12	Ellis Elec. Laboratory.....	78, 80	Midwest Broadcast Equip. Co.....
Allen-Bradley Co.....	28	Erle Resistor Corp.....	61	
Alpha Wire Corp.....	78			N
American Hard Rubber Co.....	72			Nat'l. Elec. Products Corp.....
Amperite Corp.....	76	F		National Vulcanized Fibre Co.....
Amplion Corp. of America.....	71	Fahnestock Elec. Co.....	80	Newark Wire Cloth Co.....
Amconda Wire & Cable Co.....	3	Fansteel Products Co., Inc.....	81	
Arcturus Radio Tube Co.....	63	Ferranti, Inc.....	80	O
Art Wire & Stamping Co.....	78	Frost, Herbert H., Inc.....	61	Old Masters Paper & Pulp Corp.....
Astatic Microphone Lab.....	70			
		G		P
B		General Cable Corp.....	23	Parker-Kalon Corp.....
Bakelite Corp.....	Back Cover	General Electric Co.....	26	Pierce Alro, Inc.....
Baltimore Brass Co., The.....	76	General Etching & Mfg. Co.....	75	Powell & Co., Inc., R. C.....
Brawley Felt Co., Inc., T. R.....	79	General Fabricating Co.....	79	Premier Elec. Co.....
Bunnell & Co., J. H.....	65	General Mfg. Co.....	83	
		General Radio Co.....	77	R
C		Gilby Wire Company.....	10	Radio Coil & Wire Corp.....
Cable Radio Tube Corp.....	13	Goat Radio Tube Parts, Inc.....	71	Radio Products Co., The.....
Candy & Co.....	82			Roeke Int'l. Elec. Corp.....
Central Radio Corp.....	11	H		Rola Company, The.....
Central Radio Laboratories.....	53	Hawley Products Co.....	17	Roebling's Sons Co., John A.....
Central Scientific Co.....	Second Cover	Holed-Tite Packing, Inc.....	70	
Chicago Gear Works.....	78	Hygrade Lamp Co.....	6	S
Chicago Telephone Supply Co.....	61			Schweitzer, Peter J., Inc.....
Clamp Nail Co.....	78	I		Shakeproof Lock Washer Co.....
Claro-stat Mfg. Co.....	65	Inca Mfg. Division.....	9	Shallecross Mfg. Co.....
Cleveland Wire Cloth & Mfg. Co., The.....	76	Int'l. Machine Works, Inc.....	78	Silverleaf Microphone Co.....
Condenser Corp. of America.....	15			Soreng Manegold Co.....
Crowe Name Plate & Mfg. Co.....	67	J		Spargo Wire Co.....
Crowley & Co., Henry L.....	72	Jefferson Electric Company.....	21	Sprague Specialties Co.....
		Jenkins & Adair, Inc.....	75	Summerill Tubing Co.....
D		Jensen Radio Mfg. Co.....	22	Stenode Corp. of America.....
Daven Co., The.....	83	Jewell Elec. Inst. Co.....	59	Synthane Corp., Inc.....
DeForest Radio Co.....	25	Johnson & Johnson.....	83	
DeJur-Amsco Corp.....	14			T
Diehl Mfg. Corp.....	73	K		Thomas & Skinner Steel Products Co.....
Dongan Elec. Mfg. Co.....	Third Cover	Kellogg Switchboard & Supply Co.....	77	Tung-Sol Condensers, Inc.....
Duovac Radio Tube Corp.....	8	Kester Solder Co.....	75	
				U
E		L		Universal Microphone Co., Ltd.....
Easton Coil Company.....	73	Leeds Radio Co.....	76	
Elsler Electric Corp.....	75	Lynch Mfg. Co., Inc.....	76	W
Electrad, Inc.....	79			Wireless Egert Engineering, Inc.....
Electrical Resistors, Inc.....	79	M		
Electrical Testing Labs.....	76	Maas & Waldstein Co.....	72	Z
		Magnavox Co., The.....	51	Zierlick Mfg. Works, F. R.....

GENERAL COILS

Reg. U. S. Pat.

with
Variations as Required

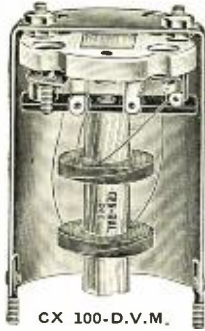

CX 100-D.V.M.

Superheterodyne Intermediate
Frequency Unit Complete
Peaked at 175 K.C.

GENERAL MFG. CO.

8065 SO. CHICAGO AVE.,

CHICAGO, ILL.

If . . . your apparatus



is built
for
quality and
performance,
consider



Accuracy to .1 of 1%.
Low distributed capacity.
Non-inductive.
Electrically noiseless.
Ranges from .1 ohm to
100 megohms.

**SUPER-
DAVOHM
RESISTORS**

All standard values in stock

THE DAVEN COMPANY
RESISTOR SPECIALISTS

General Office and Factory

158-160 Summit Street, Newark, N. J.

JOHNSON'S INDUSTRIAL TAPE

DOES not need a loud-
speaker to broadcast its
perfection.

Radio engineers all know of
and recognize its superiority,
its holding properties, lasting
adhesion and non-corrosive
action. It will outlast any
other tape put to
similar usage.

*Write for free sample and convince
yourself of its excellence*

JOHNSON & JOHNSON

New Brunswick, N. J.

MULTIPLE TAP SWITCHES

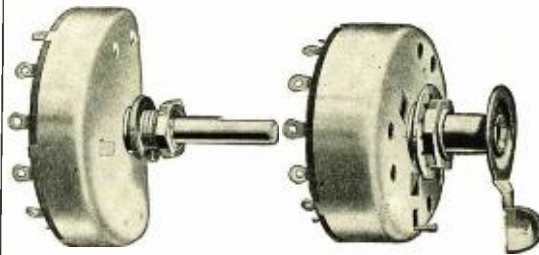

No. 7070 A

No. 7000 A

Standard and special designs
PHONO-MOTOR SWITCHES



No. 7030 A

Our plant and engineering facilities lend themselves to
the production of special requirements on short notice.
Inquiries solicited.

Soreng Manegold Co.

771 Mather St.

Chicago, Ill.

NEW IDEAS

INDUSTRY, in the year 1931, is going to need (and get) a lot of constructive thinking. Old methods will be scrapped. New ideas will be welcomed, and money will be made by those who originate economies.

If *your* thinking is along the lines of reduced overhead, lower manufacturing costs, better appearance, value or performance, check your theories against the versatile properties and uses of NVF products.



Phenolite gear for a household appliance.



Combination Phenolite and fibre high-tension fuse tube.



Phenolite double channel for refrigerated show case insulation and runner.

All NVF products—their uses, properties and workabilities are fully detailed in "Fact-Sheets of Industry." May we send you a copy?

N V F



"Let's see what National can do about it"

"I think we're working in the right direction all right, but this trial-and-error business is costing us money. Why not tell National what we are trying to accomplish here and put it up to them to furnish us with the right material for the job. After all, that's their business."

TURNING the job over to us isn't shirking responsibility—it's simply a time saving, money saving move that many a manufacturer has suggested to his engineers with happy results.

Vulcanized Fibre and Phenolite (laminated bakelite) are versatile materials applicable to a thousand-and-one uses. But to make practical the improvement ideas of designers and engineers often requires an intimate knowledge of the properties and characteristics of these materials. And right there is where National, with 58 years in this specialized business, can render you valuable service. Tell us what you're after and let us work out the practical, economical solution. Our services on development are gratis.

NATIONAL VULCANIZED FIBRE CO.
Wilmington, Delaware

Offices in principal cities

WILLIAMS PRESS, INC., NEW YORK—ALBANY



ONGAN

There is a Deadline on Quality

News of the Moment

Manufacturers of Short Wave Converter Sets

You will be interested in Dongan Power Transformers and Chokes. Many of these Transformers are already in service. Write for information.

Television

When you want a Power Supply Unit or Special type Transformer for Television we can supply it.

Ask for Details.

Beyond that Deadline we refuse to trespass.

Yes, it is possible to reduce costs and then reduce prices. But there is a point where efficiency and machinery must stop—unless, of course, Quality is taken out of the product. And progress in any industry was never achieved by eliminating Quality. Sales may mount for a brief season but the future of that product is definitely killed.

Certainly huge strides in manufacturing have been made in the Dongan Transformer plant. Every known device is utilized to build Transformers at low costs. These savings are offered to you in the shape of lower prices.

Quality, however, is still the dominate characteristic of every single Dongan Transformer. No attempt is made to compete with products that have gone beyond the Deadline. A few cents, one way or the other, sometimes makes a world of difference.

Dongan Electric Mfg. Co.

2991-3001 Franklin St., Detroit



JUN 3 1

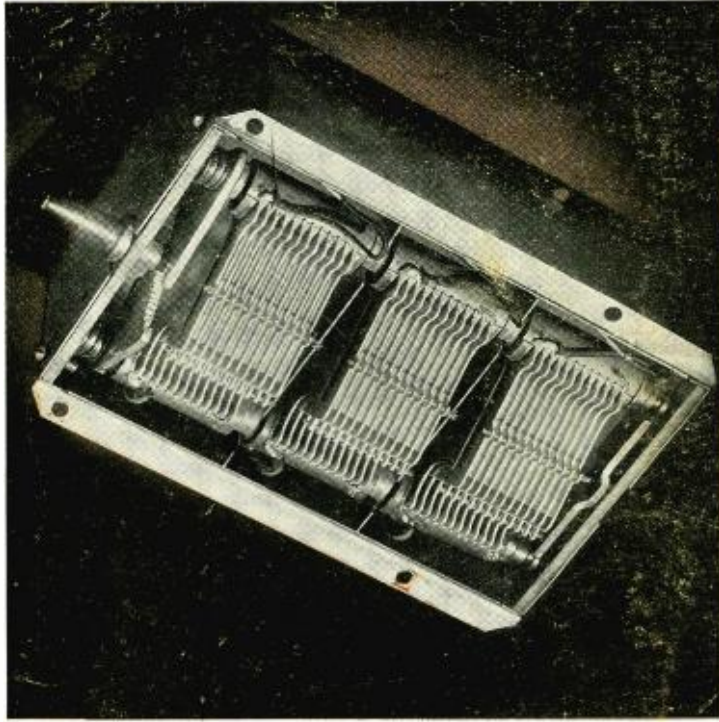

Condenser assembly used by Remler Company, Ltd. in their table sized Super-Heterodyne radio receiver.

Condenser insulation molded directly onto steel shafts

Sensitive condenser assemblies used in super-heterodyne circuits require very efficient insulation. In the condenser used by Remler Company, Ltd., the problem of fastening the plates firmly and at the same time insulating them from the steel shafts on which they are mounted, was solved in a most skilful and interesting manner.

A special Bakelite Molding Material was developed for the purpose. As a precaution against shrinking and cracking, the steel shaft is first heated to the molding temperature. Then the insulation is molded directly upon the shaft within the press. When assembled, the con-

denser plates are held firmly and in perfect alignment; and are effectively insulated against electrical losses.

Bakelite Molded insulation has been favored for innumerable radio needs since the earliest days of broadcast reception. Its high insulation value, mechanical strength, and resistance to moisture have caused it to be preferred by radio engineers. Its adaptability to multiple production, to intricate designs, and to extremely accurate formation without machining, has led it to be the choice of production men. Write for Booklet 38M, "Bakelite Molded," showing many interesting applications.

Bakelite Engineering Service — We manufacture a wide variety of Bakelite resinoid molding materials, varnishes, lacquers, enamels, cements, and other products. Twenty-one years experience in the development of these materials for radio and other uses, provides a valuable background for the cooperation offered by our engineers and laboratories.

BAKELITE CORPORATION, 247 Park Avenue, New York.

CHICAGO OFFICE, 635 West Twenty-second Street

BAKELITE CORPORATION OF CANADA, LIMITED, 163 Dufferin Street, Toronto, Ontario

BAKELITE



The registered trade marks shown above distinguish materials manufactured by Bakelite Corporation. Under the capital "B" is the

numerical sign for ten, or unlimited quantity. It symbolizes the infinite number of present and future uses of Bakelite Corporation's products.

THE MATERIAL OF A THOUSAND USES

JUN 3 1